

ENGINEERING
YOUR SPRAY SOLUTION

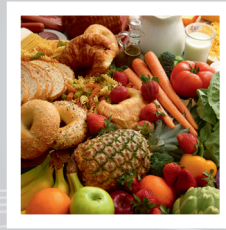

Precision Spray Nozzles for Tank and Equipment Cleaning

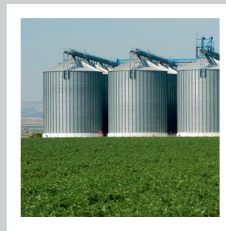

Tank and Equipment Cleaning

LECHLER NOZZLES FOR TANK AND EQUIPMENT CLEANING – ECONOMICAL, SAFE AND PROVEN OVER TIME

Lechler is a world leader in nozzle technology. For over 135 years, we have pioneered numerous groundbreaking developments in this field. Comprehensive nozzle engineering an in depth understanding of application-specific requirements to create products that offer outstanding performance and reliability.

Optimized cleaning processes

Companies all over the world in a wide range of industries rely on Lechler tank and equipment cleaning nozzles for thorough cleaning of all kinds of tank sizes, machines and equipment.

Your advantages

- None of the risks, restrictions and costs related to manual tank cleaning
- Modern nozzle technology cuts cleaning fluid consumption and reduces downtimes
- The cleaning process is trouble-free, repeatable and verifiable

New products for practically any application

The Lechler tank and equipment cleaning nozzle range features innovative drive concepts, state-of-the-art nozzle design as well as a large choice of sizes and materials. The scope of our portfolio is unique to the market and offers the perfect solution for every application.

High cleaning performance at low pressure

Thanks to their sophisticated technology, Lechler tank and equipment cleaning nozzles already achieve high cleaning performance even at low pressures. This saves on high energy costs. The nozzles are driven and lubricated by the cleaning fluid and are therefore maintenance-free and reliable.

Your experienced specialist – anywhere in the world

With subsidiaries in Hungary, the USA, England, India, China, France, Belgium, Sweden, Finland and Spain as well as qualified agents in over 40 countries, Lechler is represented all over the world. We will help you solve your cleaning problems – wherever you are.

Industries

- Chemical industry
- Food & beverage industry
- Tank and equipment engineering
- Machine tool engineering
- Cosmetics industry
- Pharmaceutical industry
- Biotechnology
- Agricultural engineering



THE ART OF MAKING THE RIGHT CHOICE



Unique range of solutions

There is no one single perfect tank and equipment cleaning nozzle. That is because requirements differ greatly in each individual application. Over the course of the years, we have developed specialized nozzles for a wide variety of different purposes. Today we offer the world's largest nozzle range. This includes everything from standard nozzles to individual nozzles for very specific tasks.

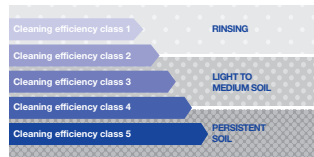

Cleaning efficiency at a sight

At first sight, finding the right nozzle for your particular application from the variety of nozzles we offer may appear overwhelming. That is why we have defined five cleaning efficiency classes - from a simple rinse to removing the most difficult soil. These individual efficiency classes, information on the tank size and recommended operating pressure allows you to quickly find the most suitable nozzle for your application.

You will find a detailed description of the cleaning efficiency classes on page 16.



Individual advice

It goes without saying that we provide you with personal service on the subject of tank and equipment cleaning and explain the different possibilities to you. Contact us and let us define the best possible solution for the most efficient cleaning.

CONTENT	Page
Applications	4-5
Planning aids	6-16
Cleaning efficiency class 1	17
Series 527	18
Series 540	20
Series 591	22
Cleaning efficiency class 2	25
»PicoWhirly«	26
»MicroWhirly«	28
»MiniWhirly«	30
»PVDF MicroWhirly«	32
»NanoSpinner«	34
»MicroSpinner«	36
»MiniSpinner«	38
»Teflon® Whirly«	40
»Gyro«	42
»PopUp Whirly«	44
Cleaning efficiency class 3	47
»HygienicWhirly«	48
»Whirly«	50
Cleaning efficiency class 4	53
»XactClean®«	54
»XactClean® HP«	56
»ACCUClean«	58
Rotation monitoring	60
Cleaning efficiency class 5	61
»IntenseClean Hygienic« 5TA 62	
»IntenseClean Hygienic« 5TB 64	
»IntenseClean«	66
Rotation monitoring	68
Static cleaning nozzles	69
Series 490/491	70
Series 524/525	71
Series 632/633	72
Series 676	74
Other nozzles	76

LECHLER NOZZLES FOR TANK AND EQUIPMENT CLEANING

For every application

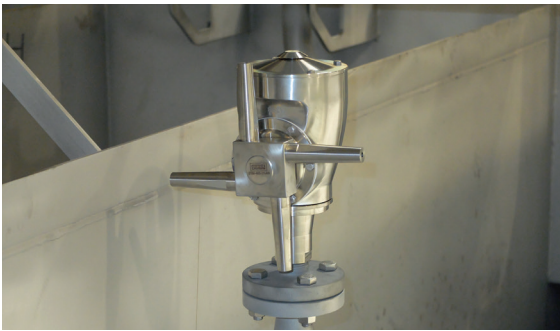

From the easiest to most difficult soils – Lechler has the optimum solution for removing soils of all kinds.

Cleaning in Place (CIP)

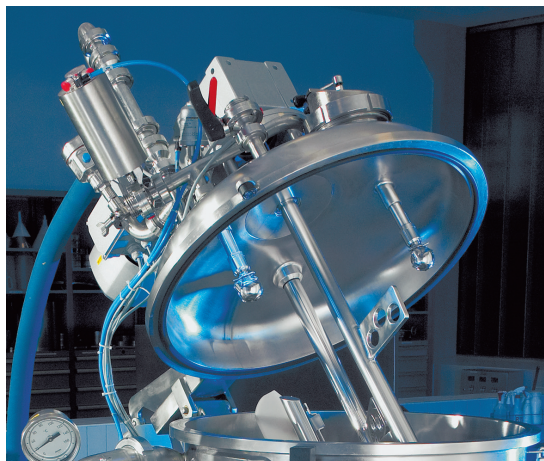

Many of Lechler's precision nozzles for tank and equipment cleaning are CIP-capable and can remain in the installation during the production process.

Hygienic equipment cleaning



Even difficult cleaning tasks with special requirements, such as in the food and beverage industry, can be performed easily with Lechler nozzles.

The right nozzle for every tank



Our extensive product range includes the right nozzle size for every application – from a small test tube to a large fermentation tank for bioethanol production.

WHAT YOU SHOULD KEEP IN MIND WHEN PLANNING

① The fundamentals of cleaning technology

Sinner's circle

Cost reduction by efficient cleaning processes

② Mechanical cleaning effects with Lechler rotating cleaning nozzles

Mechanical cleaning

Impact

Comparison of rotating cleaning nozzles and static spray balls

Influence of chemistry and temperature

Foam cleaning with nozzles

CIP- and SIP-cleaning

③ Lechler rotating cleaning nozzles designs

Operating principles

Connection options

Materials

Hygienic requirements

Nozzle wear

Material certificates

ATEX

④ Conversion tables

⑤ Cleaning efficiency classes

① The fundamentals of cleaning technology

Sinner's circle

The Sinner's circle illustrates the interplay between the four main factors for successful cleaning:

- Chemistry (choice of cleaning agent)
- Mechanical (removal of soil via pressure or friction)
- Temperature (at which cleaning is performed)
- Time (duration of the total cleaning processes)

The proportion of the individual factors as a part of the entire cleaning can be varied, provided that the total is 100 per cent. This results in significant savings potentials.

As a result, the intensification of mechanical cleaning enables the consumption of cleaning agents or the duration of cleaning to be reduced. Consequently, the mechanical factor that takes up a greater part of the Sinner's circle, while the other factors can end up being reduced.

Cost reduction by efficient cleaning processes

This is precisely where our nozzles and rotating cleaning nozzles come into play, having been specially developed for delivering a high mechanical cleaning action. Their greater efficiency helps to permanently reduce on going costs for energy and cleaning agents, and also the duration of cleaning. Consequently a one-off investment in improved nozzle technology pays for itself after only a short time.

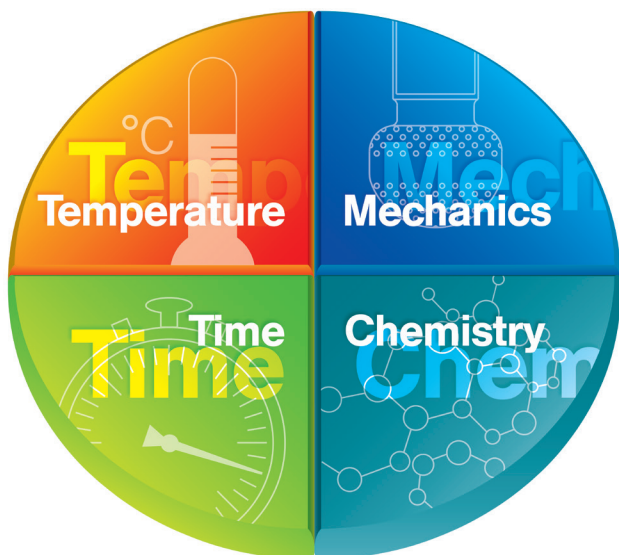

Figure 1: Sinner's circle with equal proportions of the temperature, time, chemistry and mechanical factors.

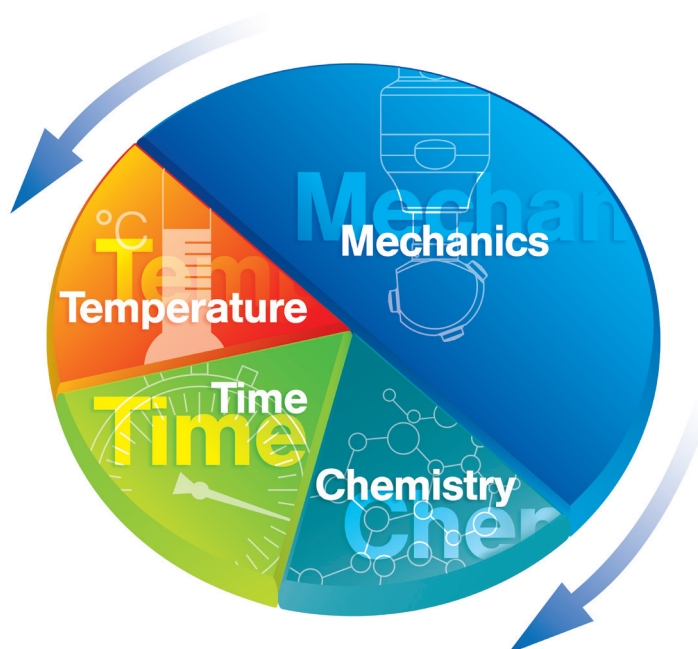

Figure 2: Lechler nozzles and rotating cleaning nozzles have high mechanical cleaning efficiency. This reduces the proportion of the other factors, as well as the resulting costs.

② **Mechanical cleaning effects with Lechler rotating cleaning nozzles**

Mechanical cleaning

Rotating cleaning nozzles deliver the greatest impact when cleaning the surface area of the tank. To achieve this, large droplets must strike at high speed. This enables thick soil to be removed that cannot dissolve in the cleaning fluid. Important influencing factors are the distance between the nozzle and wall, and the operating pressure.

If either are too great the fluid will break down into smaller droplets (see Figs. 3 and 4) and the impact will be reduced.

Besides the impact, the fluid running down the tank wall also has a significant cleaning effect. If the formed film is thick enough, the resulting shear stresses can remove light to moderate soil. In that case, unsprayed patches are less of an issue than is the case during impact cleaning (see Fig. 5).

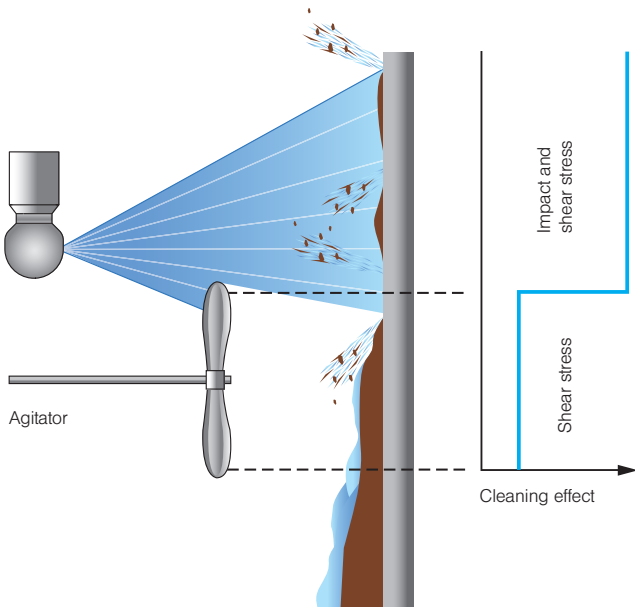

Figure 5: Cleaning mechanisms, impact and shear stress

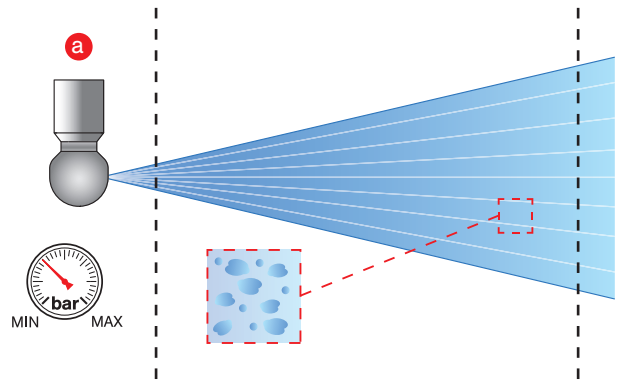

Figure 3: Rotating cleaning nozzles with recommended operating pressure

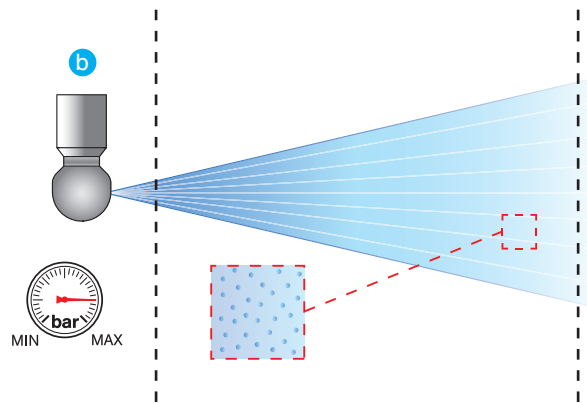

Figure 4: Rotating cleaning nozzles with operating pressure too high

WHAT YOU SHOULD KEEP IN MIND WHEN PLANNING

Impact

The force of impact when using of a liquid jet on a surface plays an important role in cleaning technology. The ratio of the force (F) to the surface (A) is referred to as the Impact (I).

$$I = \frac{\text{Impact force}}{\text{Impact surface}} = \frac{F}{A} \left[\frac{\text{N}}{\text{m}^2} \right]$$

It can be controlled via the following parameters:

Impact surface and spray angle (a)

The impact surface is the area where the droplet strikes. The smaller the surface area, the greater the impact values. Nozzles with high impact are, for example, solid stream nozzles and flat fan nozzles with a narrow spray angle (see Fig. 6).

Flow rate (b)

Increasing the flow rate by using a larger nozzle increases the impact, assuming that the

other parameters (spray angle, pressure and medium) remain the same (see Fig. 6).

Pressure

In contrast to static cleaning nozzles, there is no linear relationship between pressure and impact for rotating nozzles. With rotating nozzles, the supply pressure normally influences the rotation speed. The higher the rotation speed, the greater the tendency of rotating nozzles to atomize the fluid into much smaller droplets.

This effect has a negative influence on impact. Lechler rotating cleaning nozzles should therefore be used at the recommended operating pressure range.

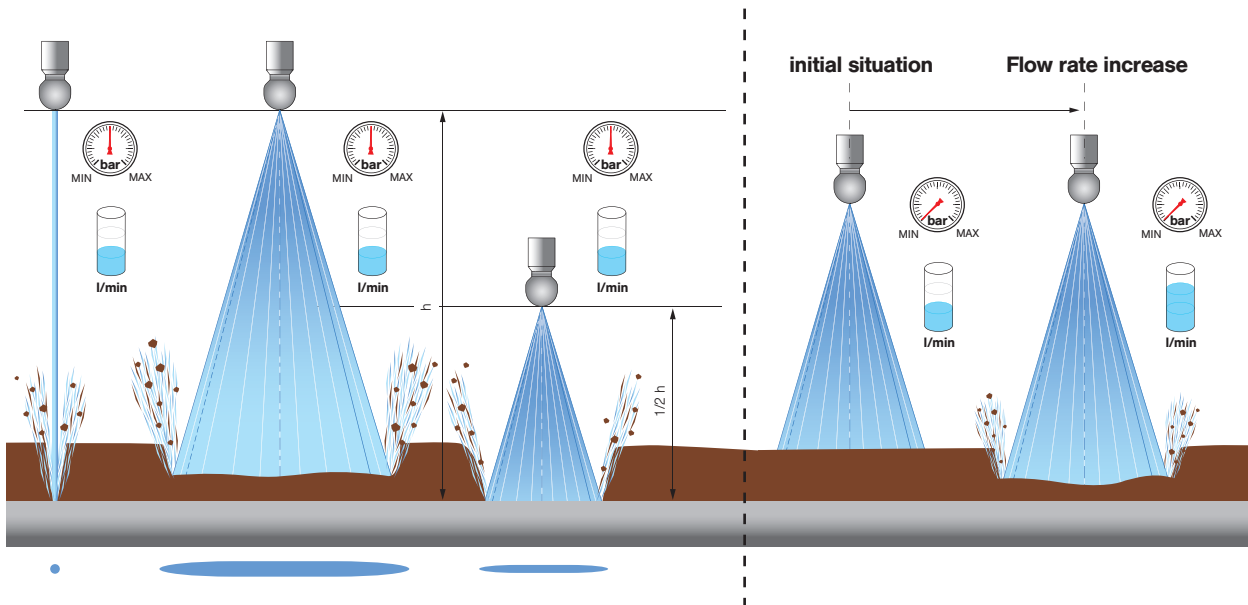

Figure 6:

a) Constant pressure and flow rate, variable spray shape and spray distance

b) Constant pressure, spray shape and spray distance, variable flow rate

Comparison of rotating cleaning nozzles and static spray balls

Due to their simple construction, static spray balls are economical and are likely to miss important areas. Whereas rotating cleaning nozzles spray the entire tank wall in a fan-like pattern, the

jets from spray balls strike only in concentrated spots. The remaining surface is simply cleaned by the shear stresses of the fluid running off (see Fig. 7). The fluid consumption is therefore significantly greater in comparison with rotating cleaning nozzles.

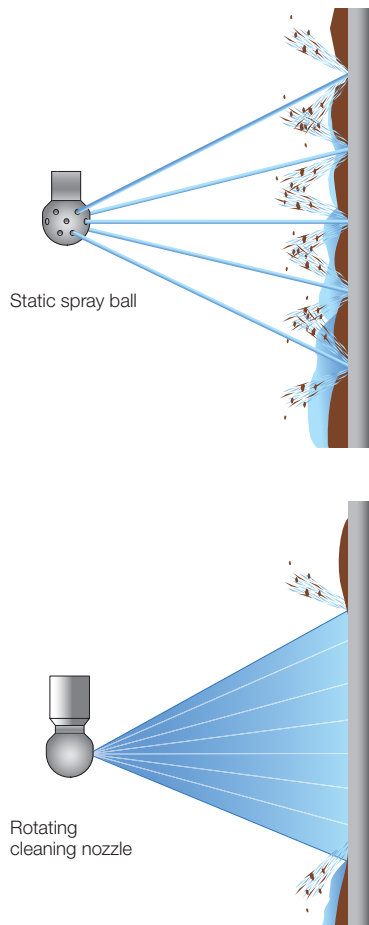

Figure 7: Comparison of rotating cleaning nozzles and static spray balls

Influence of chemistry and temperature

The chemical cleaning effect takes part in almost all tank cleaning applications when the soil is dissolved in the cleaning medium or the bonding between soil and tank surface is reduced. Higher temperatures can support the chemical cleaning effect.

Foam cleaning with nozzles

Foam cleaning is primarily based on the chemical cleaning effect. Since the foam sticks more firmly to the surface, it can be more effective than cleaning fluids that drip off quickly. The mechanical cleaning effect plays a correspondingly subordinate role. Here, the task of the nozzle is to distribute the foam evenly. Your end result for this application depends on the type of foam.

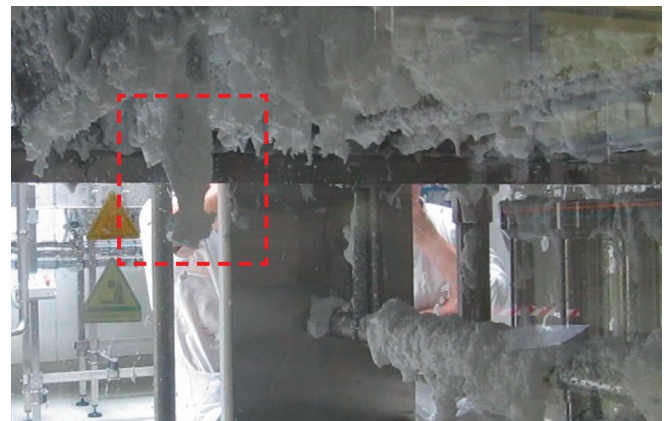

Figure 8: Foam cleaning with a Lechler PVDF MicroWhirly

CIP- and SIP-cleaning

Cleaning in Place (CIP) is one of the standard cleaning methods in the food and pharmaceutical industries. This is a process where the cleaning and disinfectant solutions circulate in the production systems during the cleaning process. The nozzles installed in the systems and do not need to be dismantled during the process.

The correct combination of steps from Sinner's circle leads to a reliable and reproducible process. Almost all Lechler rotating cleaning nozzles and static spray nozzles are capable of CIP.

If sterilization is performed after CIP-cleaning with hot water or saturated steam, this is referred to as SIP-cleaning (Sterilization in Place).

WHAT YOU SHOULD KEEP IN MIND WHEN PLANNING

③ Lechler rotating cleaning nozzles designs

Operating principles

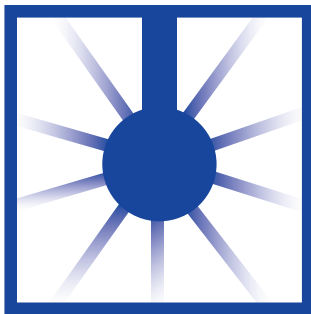

Static

Static spray balls do not rotate and therefore require considerably more fluid. They are used primarily for rinsing tanks. They are inexpensive to purchase and are very robust (trouble-free).



Free-spinning

The cleaning fluid drives the spray head by means of specially positioned nozzles. The rapidly repeated impacts removes the soil and rinses it from the tank surface. This results in optimum cleaning efficiency at low pressures in small to medium-sized tanks.

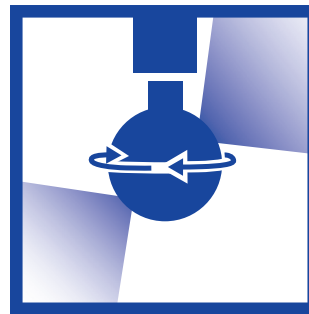

Controlled rotation

The rotating head is driven by the fluid. Either a turbine wheel with an internal gear or a hydraulic brake is used to control the rotation. This ensures that the speed remains in the optimum range even at higher pressures. The droplets produced are larger and strike the tank wall at higher speed. These rotating cleaning nozzles thus achieve an even higher impact.

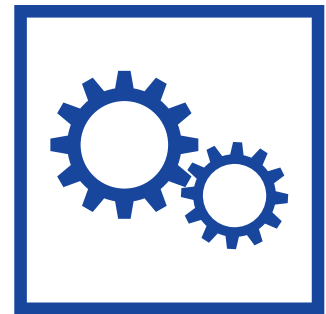

Gear-controlled

The cleaning fluid drives an internal gear by means of a turbine wheel so that the spray head rotates by two axes. The solid jet nozzles mounted on the spray head produce powerful jets. These jets sweep the entire tank surface in a pre-programmed, model-specific pattern during a spray cycle. This requires a certain minimum time. These models generate the highest impact and are therefore ideal for very large tanks and the toughest cleaning tasks.

Connection options

Lechler offers various options for connecting the rotating cleaning nozzles to the supply line:

Threaded connection

Most nozzles have a female thread that is screwed onto a male thread on the pipe.



Slip-on connection

Slip-on connections without threads are often preferred in applications with high sanitary requirements. Here, the nozzle is slipped onto the outer pipe and secured through a horizontal hole by a pin or clamp.

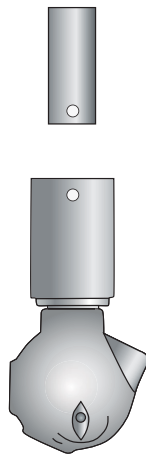

Tri-Clamp

Tri-Clamp fittings are frequently used in the food and beverage industry. Some rotating cleaning nozzles can be supplied with a compatible adapter.

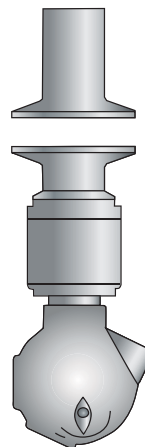

Welded connection

Almost all nozzles are also available with welded connection on request. These are particularly suitable for applications where sanitary requirements have to be taken into account. Please contact us for further information.

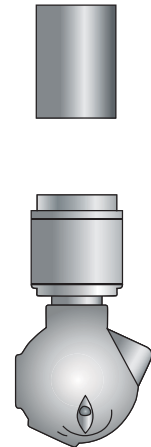

WHAT YOU SHOULD KEEP IN MIND WHEN PLANNING

Materials

Lechler tank and equipment cleaning nozzles are made of extremely high-grade materials that are designed to meet high requirements such as resistance to cleaning chemicals or temperature influences. The large choice of different materials – e.g. stainless steel AISI 316L, PVDF, PEEK or PTFE – allows nozzle selection customized to the individual application and operating conditions. In addition, the materials used for the tank and equipment cleaning nozzles are perfectly matched to each other and are thus characterized by very low wear.

The product pages for the individual nozzles provide information on the materials available for the different nozzle types.

In addition to the requirements for material resistance and wear, the materials must also be food grade for use in the beverage, food and pharmaceutical industries. Depending on the application area, the materials must meet different demands.

A large number of the materials used for Lechler tank and equipment cleaning nozzles

comply with the requirements of the FDA or conform to (EC) 1935/2004.

Further information on conformity is provided on the product pages.



The FDA, the U.S. Food & Drug Administration, is a federal agency which oversees those two industries. Materials used in making Lechler products are compliant with the requirements of FDA regulation 21 CFR for use in food applications.



The regulation (EC) No. 1935/2004 of the European Parliament regulates general safety requirements to all food and beverage contact materials.

Within this regulation, it is additionally stipulated that plastics must comply with (EU) 10/2011.

The respective logo on the product pages indicates which requirements are met.

Hygiene requirements

Lechler's tank and equipment cleaning nozzles are designed so that they meet hygiene requirements.

This is reflected, for example, in the self-draining function, minimized dead space in the nozzles as well as an external design without unnecessary gaps and edges. At the same time, the nozzles are designed with the lowest possible surface roughness.

Lechler also offers specially certified nozzles for particular hygiene requirements. The »Teflon® Whirly« and 527 series are 3A-certified, for example.



»3-A® Sanitary Symbol Council Administrative Council for Spray Cleaning Devices (78-01)«

The 3-A® council is an organization in the USA that defines criteria for the cleanability of

components in the dairy and food industry. Components and systems are examined to establish whether germs adhere to surfaces or existing soiling can be removed.

Components and systems are awarded a »3-A® certificate« only if they are easy to clean or if soil cannot be deposited in the first place.



European Hygienic Engineering and Design Group. The EHEDG also checks and certifies the hygienic design of components. Its procedure is similar to that of 3-A®. The »HygienicWhirly« series is EHEDG-certified.

The respective logo on the product pages indicates which requirements are met.

Nozzle Wear

Nozzle wear depends mainly on the operating conditions.

Like with all rotating parts, the bearing assembly is subjected to the highest amount of stress. The following operating conditions accelerate wear:

- Solids in the fluid and hard particles
- Use in a chemically aggressive environment
- Spraying of chemically aggressive substances
- Operating the nozzle above the recommended pressure range or temperature.

Material certificates

Material certificates in accordance with DIN EN 10204 can be issued on request for almost all Lechler tank and equipment cleaning nozzles.

ATEX



Lechler offers specially designed nozzle series for use in explosive atmospheres. The »MicroWhirly« and »Whirly« series have an ATEX approval that was issued by an external certification institute.

④ Conversion tables

p Pressure

Unit	Conversion			
	bar	Pascal [Pa] = N/m ²	psi	lb/sq ft
1 bar	1	1·10 ⁵	14.5	2089
1 Pascal [Pa]	1·10 ⁻⁵	1	14.5·10 ⁻⁵	0,0209
1 psi	0.06895	6895	1	144
1lb/sq ft	0.479·10 ⁻³	47.9	6.94·10 ⁻³	1

V Volume

Unit	Conversion			
	l	m ³	Imp. gal	US gal
1 l (1 dm³)	1	1·10 ⁻³	0.22	0.264
1 m³	1000	1	220	264.2
1 Imp. gallon	4.546	4.546·10 ⁻³	1	1.201
1 US gallon	3.785	3.785·10 ⁻³	0.8327	1

V̇ Flow rate

Unit	Conversion				
	l/min	l/s	m ³ /h	US gal/min	Imp. gal/min
1 l/s	60	1	3.6	15.85	13.20
1 l/min	1	0.01667	0.06	0.2642	0.22
1 m³/h	16.67	0.28	1	4.40	3.66
1 US gal./min	3.785	0.0631	0.227	1	0.8327
1 Imp. gal./min	4.546	0.076	0.273	1.201	1

ρ Change in specific weight

$\dot{V}_w = \frac{\dot{V}_R}{X}$	$\dot{V}_w = \text{Flow rate (water) [l/min, l/h]}$
$\dot{V}_R = \dot{V}_w \sqrt{\frac{\rho_w}{\rho_R}} = \dot{V}_w \cdot X$	$\dot{V}_R = \text{Flow rate of liquid, with a specific weight that differs from 1}$
$X = \sqrt{\frac{\rho_w}{\rho_R}}$	X = Multiplier ρ = Specific weight [kg/m ³]
$\frac{\rho_R}{X}$	500 600 700 800 900 1000 1100 1200
$\frac{\rho_R}{X}$	1.41 1.29 1.20 1.12 1.06 1.0 0.95 0.91
$\frac{\rho_R}{X}$	1300 1400 1500 1600 1700 1800 1900 2000
$\frac{\rho_R}{X}$	0.88 0.85 0.82 0.79 0.77 0.75 0.73 0.71

p/V̇ Pressure/Flow rate

Valid for single-fluid nozzles and rotating nozzles except for axial-flow full cone nozzles	$\dot{V}_2 = \sqrt{\frac{\rho_2}{\rho_1}} \cdot \dot{V}_1$ [l/min]	Ratio of both, given and required pressure – flow rate values
	$\rho_2 = \left(\frac{\dot{V}_2}{\dot{V}_1}\right)^2 \cdot \rho_1$ [bar]	
Valid for axial-flow full cone nozzles	$\dot{V}_2 = \left(\frac{\rho_2}{\rho_1}\right)^{0.4} \cdot \dot{V}_1$ [l/min]	
	$\rho_2 = \left(\frac{\dot{V}_2}{\dot{V}_1}\right)^{2.5} \cdot \rho_1$ [bar]	

All flow rate data of this brochure have been measured with water and consider the individual flow parameters of the nozzle designs.

WHAT YOU SHOULD KEEP IN MIND WHEN PLANNING

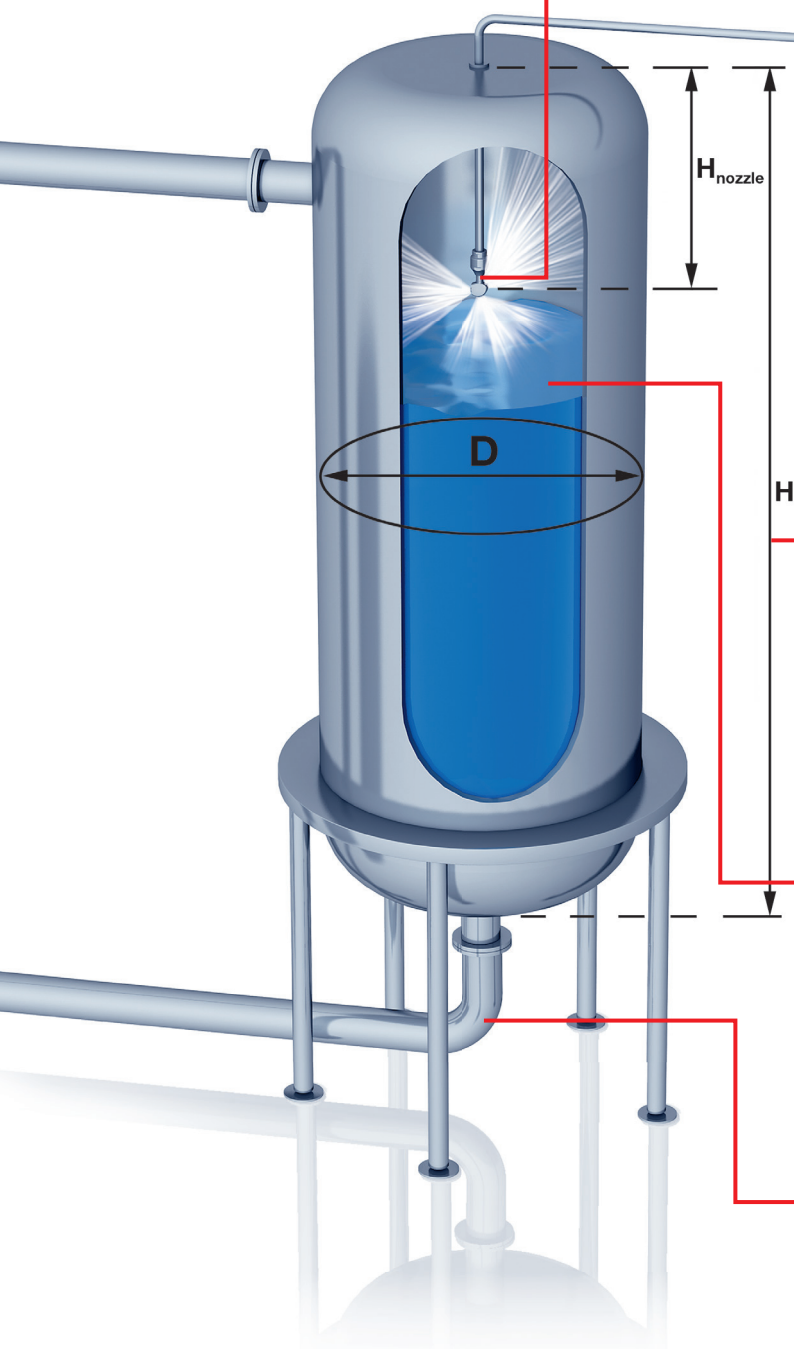

Nozzle selection

The choice of the right Lechler rotating cleaning nozzle or static spray ball is determined primarily by the type of soil to be cleaned and the tank diameter. You can find this information on the product pages. It must be guaranteed that the diameter of the tank to be cleaned is smaller than the specified maximum possible tank diameter of the nozzles.

Pump and pipes

The pipe size used depends mainly on the required flow rate and should be chosen so that the pressure losses in the pipe system are as low as possible. It must be guaranteed that the required static operating pressure is available directly at the nozzle. The pump power must be matched to this.

Arrangement

The nozzles must be positioned in the upper part of the tank where possible. The following recommendation applies:

$$H_{\text{nozzle}} = 1/3 \cdot H_{\text{tank}}$$

In addition, it must be ensured that sufficient cleaning fluid strikes the tank top.

Filling level

If possible, the nozzle should not come into contact with the product during production. The nozzle should be positioned above the maximum product level in the tank.

Tank drainage rate

The tank drainage rate is to be selected to prevent the level of liquid from rising during the cleaning process. Make sure the drain can handle whatever volume you put into the tank. (See chart on the right)

1"	23 l/min
1 1/2"	50 l/min
2"	87 l/min
2 1/2"	132 l/min
3"	190 l/min
4"	330 l/min

Number of nozzles

When cleaning large tanks or complex installations, you will need to install several nozzles. The nozzles must be positioned for the spray jets to overlap. These nozzles effectively clean the tank surface area.

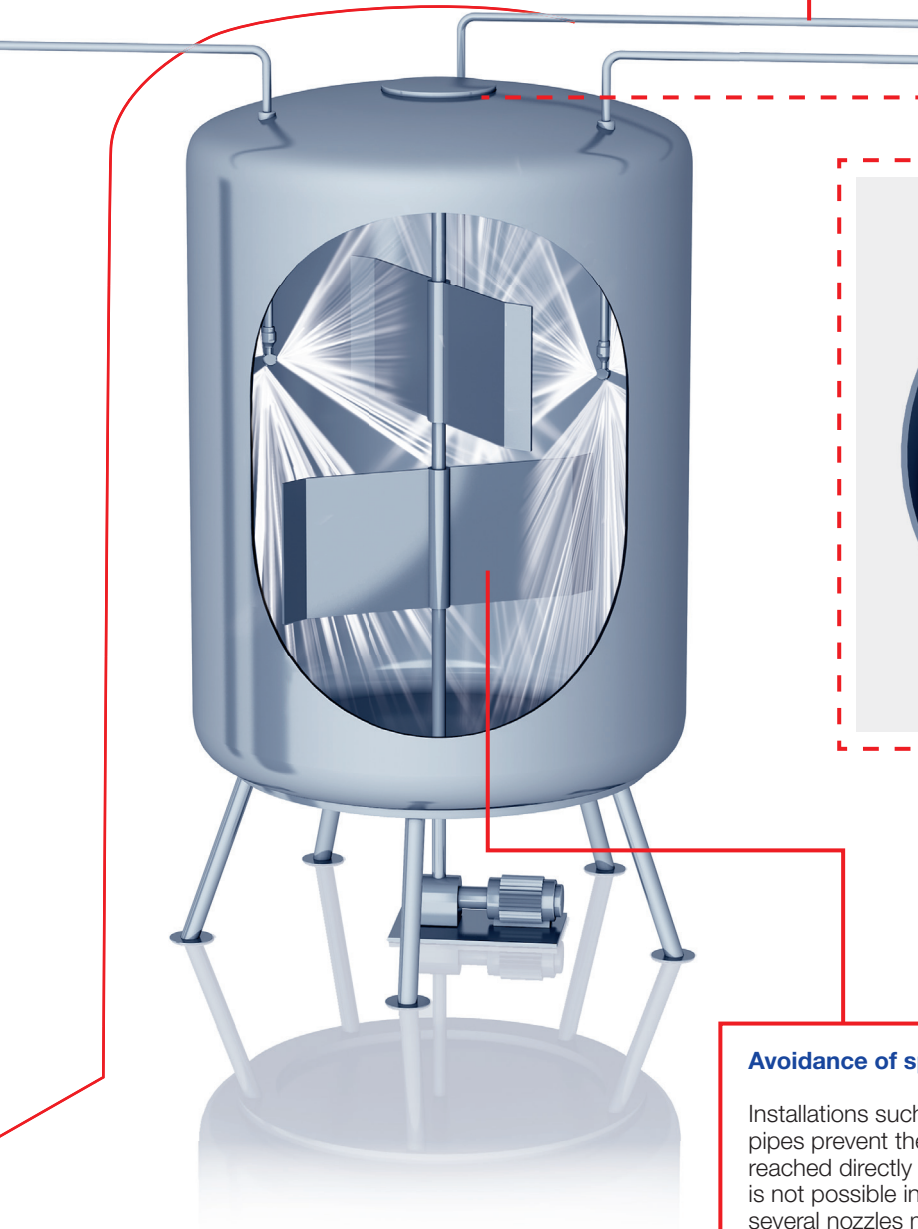

Avoidance of spray shadows

Installations such as agitators, baffle plates or pipes prevent the areas behind them from being reached directly by the spray jet. Impact cleaning is not possible in these locations. For this reason, several nozzles must be installed if the tank contains equipment such as agitators or pipes. The number of nozzles should be chosen so that the spray shadows of the individual nozzles are eliminated. In addition, static spray nozzles can also be used for targeted removal of deposits left as a result of spray shadows or in areas that are difficult to clean.

WHAT YOU SHOULD KEEP IN MIND WHEN PLANNING



⑤ Cleaning efficiency classes

Lechler precision nozzles for tank and equipment cleaning are divided into different cleaning efficiency classes. A distinction is made between five different cleaning efficiency classes.

The subdivision into cleaning efficiency classes 1-5 is intended to facilitate nozzle selection for users. These classes make it possible to find the right nozzle for the respective application.

Every nozzle from Lechler is assigned to a class. The respective class is suitable for specific cleaning tasks.

First, the required cleaning efficiency class is defined on the basis of the soil type – rinsing, light to medium soil, persistent soil. Several classes are generally always suitable for one type of soiling. It is not possible or expedient to differentiate exactly between the soil types or recommended nozzle types since there are a large number of different applications. The information should be seen as recommendations intended to make it easier to choose the right nozzle.

If your application is to clean a non-adhering powder material from a tank surface, for example, the cleaning task can be defined as „rinsing“.

The nozzle series in cleaning efficiency class 1, e.g. static spray ball, or class 2, e.g. »MicroWhirly« or »MiniSpinner«, are suitable for this.

In the next step, the maximum possible tank diameter and the flow rate range of the individual series are considered. Lechler static spray balls are very economical. For cleaning medium soil, Lechler MicroSpinners or MiniSpinners are recommended.

However, it is also possible that there will be no nozzle series from the two cleaning efficiency classes that is suitable at first sight in the case of very large tanks. To check this, it is recommended to refer to the overview page of the respective cleaning efficiency class. Using the number line, it is possible to see at a glance whether there is a suitable series for

the specific tank diameter in the corresponding cleaning efficiency class. The following possibilities exist if there is no recommended series for the required tank diameter:

- Several nozzles are positioned in the tank so that the distance between nozzle and tank is within the required dimensions.
- By referring to the overview pages of the different cleaning efficiency classes, choose a suitable nozzle series for the respective tank diameter.



Static cleaning nozzles

In addition to the classes described above, there is also an additional subdivision into static cleaning nozzles. These include flat fan or full cone nozzles, for example. These can be used for the shadowing effect to provide complete spray coverage.

RELIABLE RINSING OF TANKS AND EQUIPMENT INSTALLATIONS

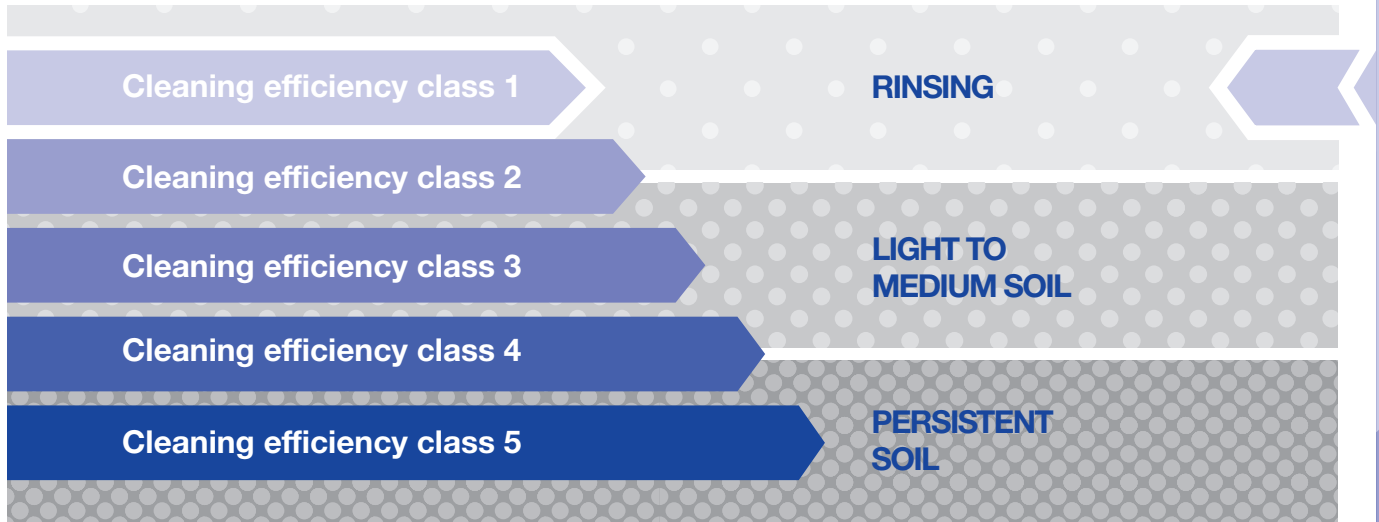

Cleaning efficiency class 1

These static spray balls of cleaning efficiency class 1 are designed for hygienic rinsing with a flow rate of 14 to 460 l/min at 2 bar, as is frequently required in the food and beverage industry. In addition to liquid media, the static spray balls can also be operated with media such as steam and air and

are also suitable for CIP- (Cleaning in Place) and SIP-cleaning (Sterilization in Place).

Lechler products in this class are also designed for operation at higher temperatures and guarantee high process reliability.



 **Operating principles**
Static

 **Flow rates at 2 bar**
14 to 460 l/min

 **Recommended operating pressures**
1.5 to 3 bar

 **Max. temperatures**
to 200 °C



Static spray balls Series 527

Series 527

The 3A[®] certification also makes the products of series 527 suitable for areas with the highest of hygiene requirements. They clean with powerful solid jets, have a high surface quality and are also reliably resistant to high temperatures.

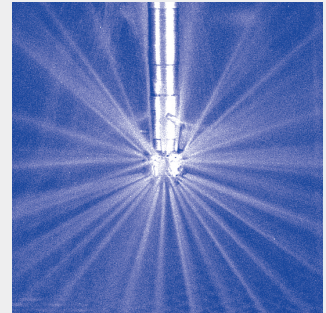

Max. tank diameter [m]



Material
Stainless steel
AISI 316L



Max. temperature
200 °C



Recommended operating pressure
1.5 bar



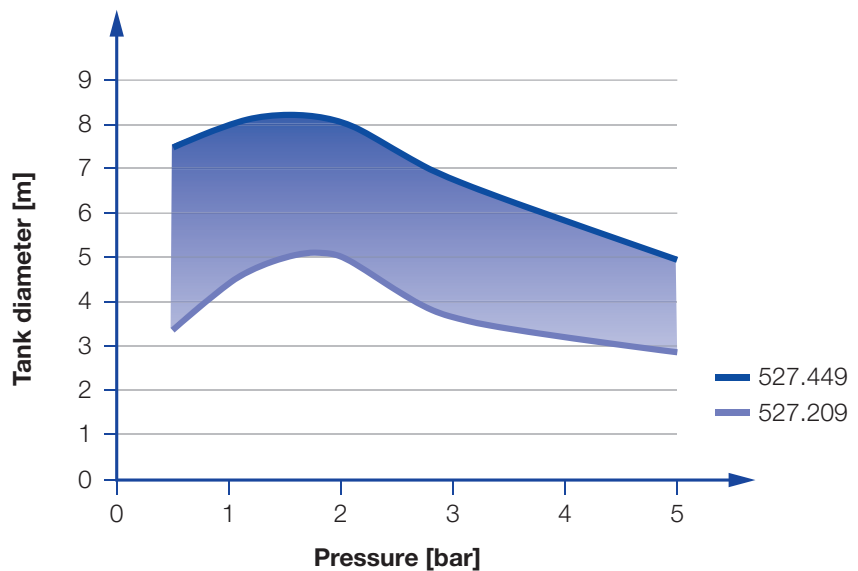

Installation
Operation in every direction is possible

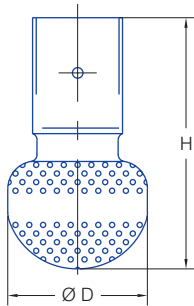

Overview of the tank diameter, depending upon the pressure of series 527



Slip-on connection
ASME - BPE 1997 (OD-Tube)

Spray angle 	Ordering number Type	E Ø [mm]	\dot{V} [l/min]					Height H [mm]	Dia- meter D [mm]	For outer pipe diameter		Max. tank diameter [m]
			p [bar] ($p_{max} = 5$ bar)							[mm]	[in]	
			1	2	3	5	at 40 psi [US gal./ min]					
360° 	527.209.1Y.00.75	0.8	42	60	73	95	19	68	32	19.05	3/4"	5.2
	527.289.1Y.01.50	1.1	120	170	208	269	50	116	65	38.1	1 1/2"	6.0
	527.449.1Y.02.00	1.7	297	420	514	664	127	152	102	50.8	2"	8.2

E = Narrowest free cross-section

The maximum tank diameter shown above applies for the recommended operating pressure and is indicative only. The cleaning result is also affected by the type of soiling.

Information on operation

In most applications, static spray balls do not deliver the same cleaning power as rotating nozzles, anyway they do have advantages that make them indispensable for certain tasks:

- No moving parts
- Self-draining
- Easy to inspect
- Proven use in hygienically sensitive environments

Should a rotating nozzle stop turning for some reason, parts of the tank may remain uncleaned. This cannot happen with spray balls. However, gaps can occur in the spray pattern if individual openings are blocked with soil.

Compared to rotating nozzles, static spray balls usually need two to three times the amount of liquid.

Slip-on information

- R-clip made of stainless steel AISI 316L is included.
- Depending on diameter of the adapter the flow rate can increase due to leakage between connecting pipe and static spray ball.



Static spray balls Series 540 / 541

Series 540 / 541

The robust series 540 / 541 have a threaded connection and an especially compact design. They can also be used at high temperatures as well as for the output of steam and air.

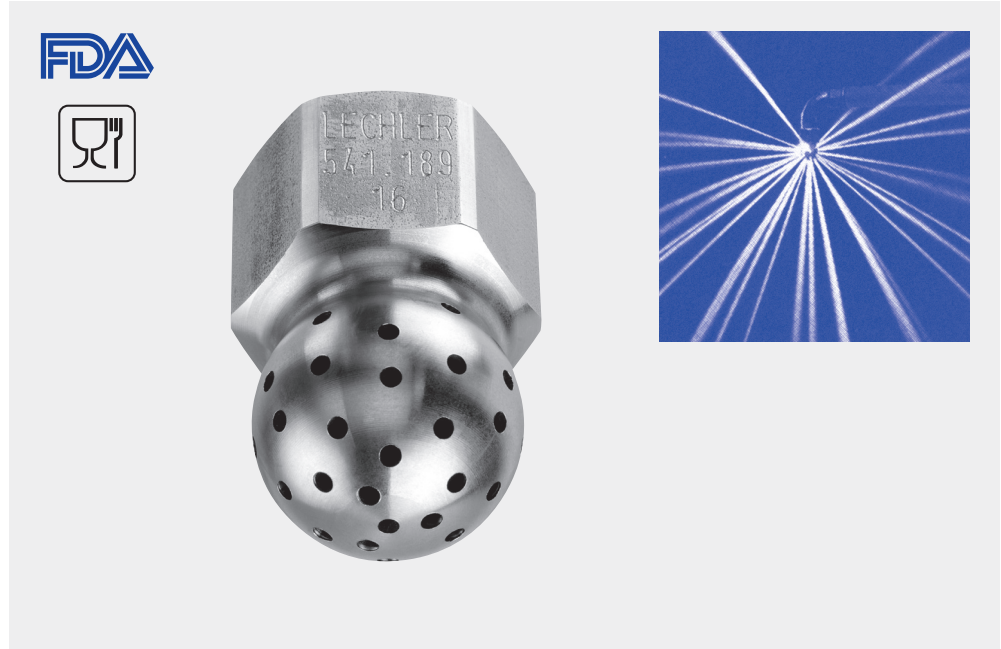

Max. tank diameter [m]



Material
Stainless steel
AISI 303



Max. temperature
200 °C



Recommended operating pressure
3 bar



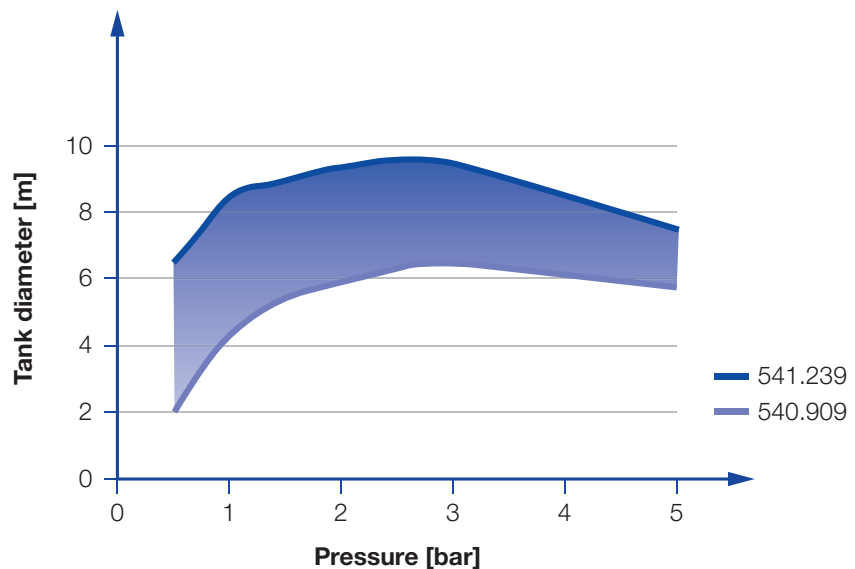

Installation
Operation in every direction is possible

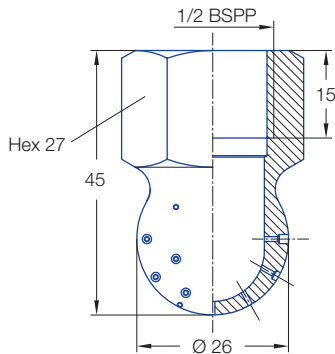

Overview of the tank diameter, depending upon the pressure of series 540 / 541



Spray angle 	Ordering number Type	E Ø [mm]	\dot{V} [l/min]					Max. tank diameter [m]
			p [bar] ($p_{max} = 10$ bar)					
			0.5	1	2	3	at 40 psi [US gal./ min]	
	540.909.16	0.8	9	13	18	22	6	6.5
	540.989.16	1.0	14	20	28	34	9	7.0
	541.109.16	1.5	29	40	57	70	18	7.5
	541.189.16	2.0	45	64	90	110	28	8.3
	541.239.16	2.3	59	83	118	145	37	9.5

E = Narrowest free cross-section · NPT on request

The maximum tank diameter shown above applies for the recommended operating pressure and is indicative only. The cleaning result is also affected by the type of soiling.

Information on operation

In most applications, static spray balls do not deliver the same cleaning power as rotating nozzles, anyway they do have advantages that make them indispensable for certain tasks:

- No moving parts
- Self-draining
- Easy to inspect
- Proven use in hygienically sensitive environments

Should a rotating nozzle stop turning for some reason, parts of the tank may remain uncleaned. This cannot happen with spray balls. However, gaps can occur in the spray pattern if individual openings are blocked with soil.

Compared to rotating nozzles, static spray balls usually need two to three times the amount of liquid.



Static spray balls Series 591

Series 591

The series 591 has proven its abilities in many areas of use, thanks to its design and large product range. It can be used in areas with high hygiene requirements and high temperatures. It is also available in special materials or with special connections on request.



	Max. tank diameter [m]	0	1	2	3	4	5	6	7	8	9
--	-------------------------------	---	---	---	---	---	---	---	---	---	---



Materials
Stainless steel
AISI 316Ti,
Pin: Stainless steel
AISI 316L



Max. temperature
200 °C



Recommended operating pressure
3 bar





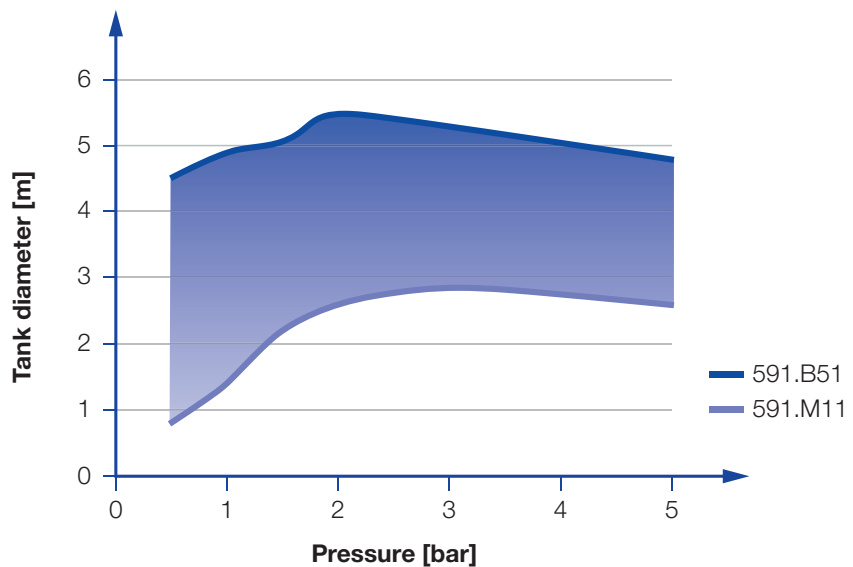

Installation
Operation in every direction is possible

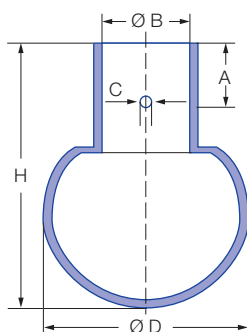

Overview of the tank diameter, depending upon the pressure of series 591



Slip-on connection
DIN 11850, row 1

Spray angle 	Ordering number Type	E Ø [mm]	\dot{V} [l/min]					Dimensions approx. [mm]						Max. tank diameter [m]
			p [bar] (p _{max} = 5 bar)					Ø D	Height H	Con- nection B	Slip-on	C	A	
			0.5	1	2	3	at 40 psi [US gal./ min]							
360° 	591.M11.17.00	0.8	7	10	14	17	4	20	32.5	8.2	DN8	2.2	9.0	2.8
	591.X11.17.00	1.2	25	35	49	61	15	24	37.5	12.2	DN10	2.2	9.0	2.2
	591.Y11.17.00	1.2	49	70	99	121	31	30	42	18.2	DN15	2.2	9.0	2.5
	591.A21.17.00	2.0	91	128	181	222	56	40	53	22.2	DN20	2.5	9.0	3.5
	591.B31.17.00	2.1	130	183	259	318	80	64	90	28.2	DN25	2.8	18.0	5.2
	591.B51.17.00	3.0	206	292	412	505	128	64	90	28.2	DN25	2.8	18.0	5.4
180° 	591.A23.17.00	2.0	74	105	148	182	46	40	53	22.2	DN20	2.5	9.0	2.5
	591.B53.17.00	3.0	146	207	292	358	91	64	90	28.2	DN25	2.8	18.0	4.6
180° 	591.B32.17.00	2.1	103	145	205	251	64	64	90	28.2	DN25	2.8	18.0	5.2
	591.D42.17.00	2.2	230	325	460	563	142	90	122	52.3	DN50	3.3	25.0	5.5

E = Narrowest free cross-section

Female thread and more slip-on sizes on request

The maximum tank diameter shown above applies for the recommended operating pressure and is indicative only. The cleaning result is also affected by the type of soiling.

Information on operation

In most applications, static spray balls do not deliver the same cleaning power as rotating nozzles, anyway they do have advantages that make them indispensable for certain tasks:

- No moving parts
- Self-draining
- Easy to inspect
- Proven use in hygienically sensitive environments

Should a rotating nozzle stop turning for some reason, parts of the tank may remain uncleaned. This cannot happen with spray balls. However, gaps can occur in the spray pattern if individual openings are blocked with soil.

Compared to rotating nozzles, static spray balls usually need two to three times the amount of liquid.

Slip-on information

- R-clip made of stainless steel AISI 316L or similar is included.
- Depending on diameter of the adapter the flow rate can increase due to leakage between connecting pipe and static spray ball.

PERFECT RINSING AND REMOVAL OF LIGHT SOILING



Cleaning efficiency class 2

The typical task profile of the rotating nozzles in cleaning efficiency class 2 includes rinsing tasks and the removal of light soiling, particularly the kind that frequently occurs in the food and beverage industry as well as in the chemical and pharmaceutical industry. Suitable rotating nozzles, which can also be used for CIP-cleaning (Cleaning in

Place), are available for practically all tank diameters from small to large.

The Lechler products in this class are free-spinning and made from particularly high-grade materials such as stainless steel, PVDF, PEEK and Teflon®. This ensures the use of a wide range of different cleaning agents.



 Max. tank diameter [m]	0	1	2	3	4	5	6	7	8	9
---	---	---	---	---	---	---	---	---	---	---

 **Operating principles**
Free-spinning

 **Flow rates at 2 bar**
8 to 639 l/min

 **Recommended operating pressures**
2 to 3 bar

 **Max. temperatures**
50 to 200 °C



Rotating cleaning nozzle »PicoWhirly« Series 500.234

Series 500.234

The PicoWhirly works with rotating solid jets and is also suitable for cleaning at very high temperatures. This rotating cleaning nozzle with kolsterised slide bearing is made entirely from stainless steel and can also be used in very small spaces, thanks to its extremely compact construction.



Function video

Scan the QR-code
or go to:
[www.lechler.de/
PicoWhirlyGB](http://www.lechler.de/PicoWhirlyGB)



Max. tank diameter [m]

0

1

2

3

4

5

6

7

8

9



Material

Stainless steel
AISI 316L



Max. temperature

200 °C



Recommended operating pressure

3 bar



Installation

Operation in every
direction is possible



Filtration

Line strainer with
a mesh size of
0.3 mm/50 mesh



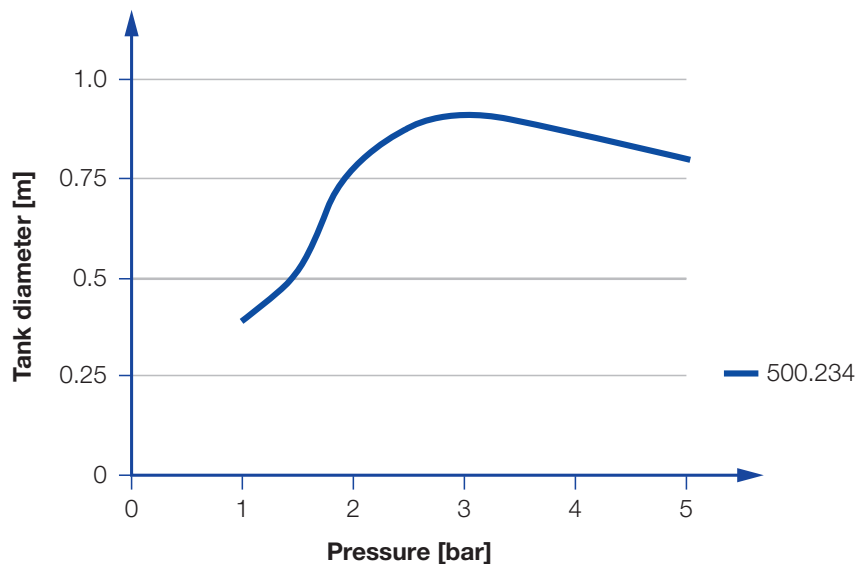

Bearing

Kolsterised
slide bearing

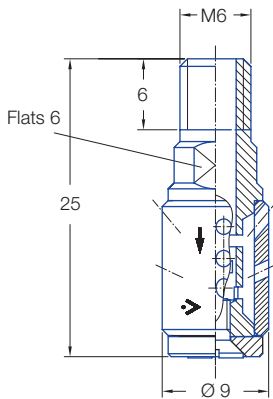

Overview of the tank diameter, depending upon the pressure of series 500.234



Spray angle 	Ordering number Type	E Ø [mm]	\dot{V} [l/min]				Max. tank diameter [m]
			p [bar] ($p_{max} = 5$ bar)				
			1	2	3	at 40 psi [US gal./ min]	
300° 	500.234.G9.00	1.8	5.7	8.0	9.8	2.5	0.9

E = Narrowest free cross-section

The maximum tank diameter shown above applies for the recommended operating pressure and is indicative only. The cleaning result is also affected by the type of soiling.

Information on operation

- Operation with compressed air only for short-term usage. Operation above the recommended operating pressure means higher wear and smaller droplets. This might have adverse effects on the cleaning result.



Rotating cleaning nozzle »MicroWhirly« Series 566

Series 566

The MicroWhirly, with effective flat fan nozzles, is licensed for contact with food. Thanks to the robust slide bearing made from PEEK, the MicroWhirly has a particularly long service life. The MicroWhirly is alternatively available with an internal or external thread and in an ATEX version, which allows it to be adapted to a wide range of uses.



Function video

Scan the QR-code
or go to:
[www.lechler.de/
MicroWhirlyGB](http://www.lechler.de/MicroWhirlyGB)



Max. tank diameter [m]

0 | 1 | 2 | 3 | 4 | 5 | 6 | 7 | 8 | 9



Materials

Stainless steel
AISI 316L, PEEK



Max. temperature

130 °C
90 °C ATEX Version



Recommended operating pressure

2 bar



Installation

Operation in every
direction is possible



Filtration

Line strainer with
a mesh size of
0.3 mm/50 mesh
0.2 mm/80 mesh
ATEX Version



Bearing

Slide bearing made
of PEEK

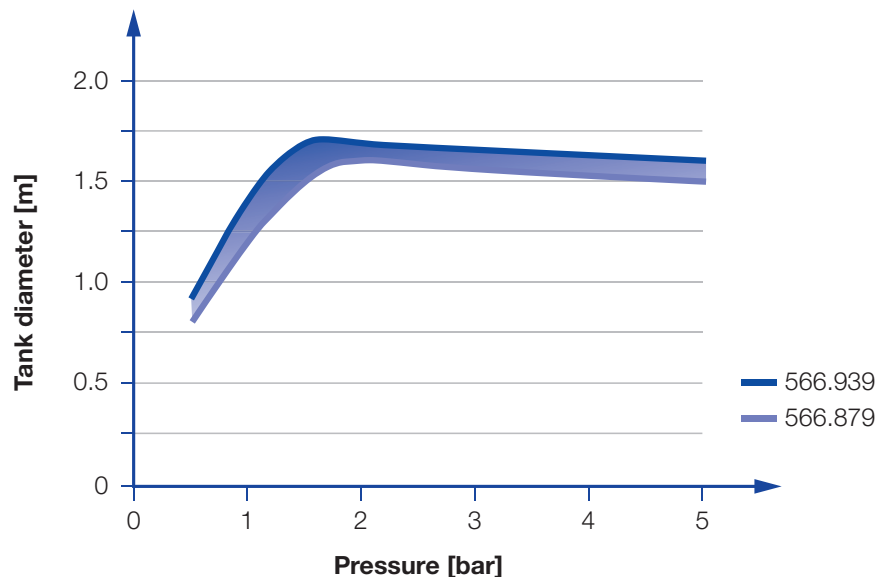

Overview of the tank diameter, depending upon the pressure of series 566

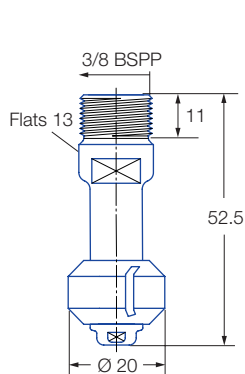



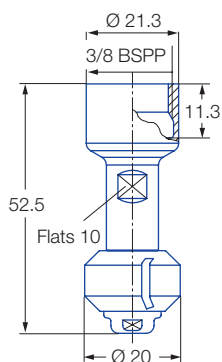

3/8 BSPP male thread

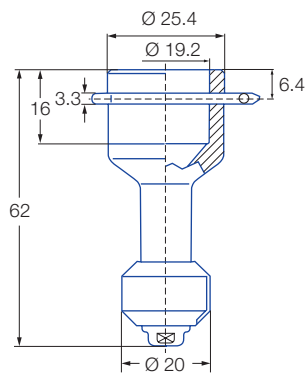

3/8 BSPP female thread



Slip-on connection
ASME - BPE 1997 (OD-Tube)

Spray angle 	Ordering number				E Ø [mm]	V̇ [l/min]				Max. tank diameter [m]
	Type	Connection				p [bar] (p _{max} = 6 bar)				
		3/8 BSPP* male	3/8 BSPP* female	3/4" Slip-on		1	2	3	at 40 psi [US gal./ min]	
180° 	566.873.1Y	AE	AF	TF	1	12	15	18	5	1.6
	566.933.1Y	AE	AF	TF	2.4	15	21	26	7	1.7
180° 	566.874.1Y	AE	AF	TF	1	12	15	18	5	1.6
	566.934.1Y	AE	AF	TF	2.4	15	21	26	7	1.7
360° 	566.879.1Y	AE	AF	TF	1	12	15	18	5	1.6
	566.939.1Y	AE	AF	TF	2.4	15	21	26	7	1.7

E = Narrowest free cross-section · *NPT and weld-on version on request

The maximum tank diameter shown above applies for the recommended operating pressure and is indicative only. The cleaning result is also affected by the type of soiling.

Information on operation

- Operation with compressed air only for short-term usage. Operation above the recommended operating pressure means higher wear and smaller droplets. This might have adverse effects on the cleaning result.

Slip-on information

- R-clip made of stainless steel AISI 316L is included (Ordering no.: 095.022.1Y.50.94.E).
- Depending on diameter of the adapter the flow rate can increase due to leakage between connecting pipe and rotating cleaning nozzle.

Example of ordering with ATEX approval. No FDA and (EG) 1935/2004 conformity.

Unit group / category / zones:

II 1 GD c T4 T 120 °C +5 °C ≤ Ta ≤ +90 °C
for zone 0, 1, 2 (gas atmosphere)
for zone 20, 21, 22 (dust atmosphere)



Example Type + Connection = Ordering no.
of ordering: 566.873.1Y.XX.EX + AE = 566.873.1Y.AE.EX

Example of ordering with FDA and (EG) 1935/2004 conformity.



All Materials are suitable for contact with food.



Example Type + Connection = Ordering no.
of ordering: 566.873.1Y.XX + AE = 566.873.1Y.AE



Rotating cleaning nozzle »MiniWhirly« Series 500.186

Series 500.186

The MiniWhirly made from POM is the economical entry-level model in the area of tank cleaning. The rotating nozzle has effective flat fan nozzles and was specifically designed for applications in barrel and canister cleaning.



Function video

Scan the QR-code
or go to:
www.lechler.de/MiniWhirlyGB



Max. tank diameter [m]

0 | 1 | 2 | 3 | 4 | 5 | 6 | 7 | 8 | 9



Materials

POM,
Stainless steel
AISI 316



Max. temperature

50 °C



Recommended operating pressure

2 bar



Installation

Vertically facing
downward



Filtration

Line strainer with
a mesh size of
0.3 mm/50 mesh



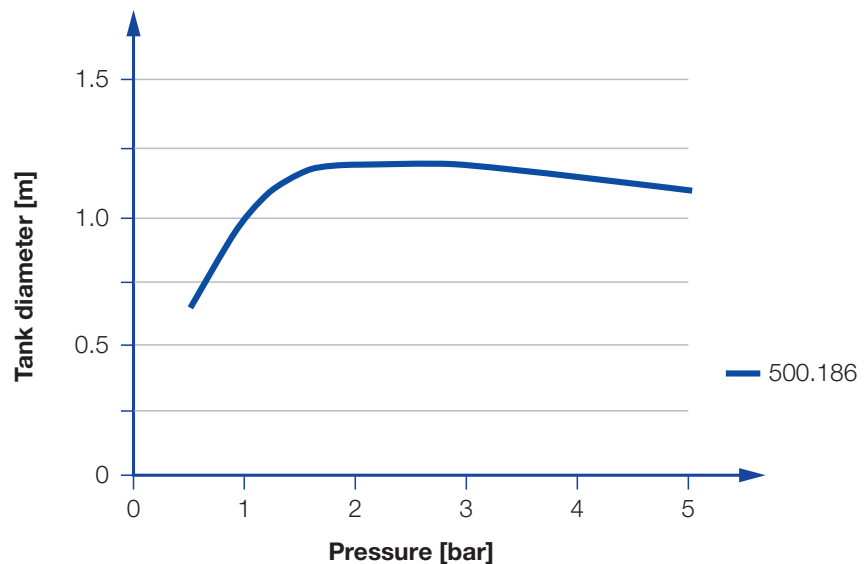

Bearing

Ball bearing made
of stainless steel

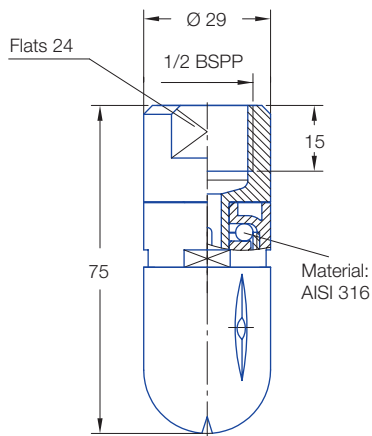

Overview of the tank diameter, depending upon the pressure of series 500.186



Spray angle 	Ordering number Type	E Ø [mm]	V̇ [l/min]				Max. tank diameter [m]
			p [bar] (p _{max} = 5 bar)				
			1	2	3	at 40 psi [US gal./ min]	
300° 	500.186.56.AH	1.9	13	18	22	6	1.3

E = Narrowest free cross-section

The maximum tank diameter shown above applies for the recommended operating pressure and is indicative only. The cleaning result is also affected by the type of soiling.

Information on operation

- Operation with compressed air only for short-term usage. Operation above the recommended operating pressure means higher wear and smaller droplets. This might have adverse effects on the cleaning result.

2
Cleaning efficiency class

3
Cleaning efficiency class

4
Cleaning efficiency class

5
Cleaning efficiency class

Static cleaning nozzles



Rotating cleaning nozzle »PVDF MicroWhirly« Series 500.191

Series 500.191

The PVDF MicroWhirly is made entirely from PVDF and designed to work in a corrosive environment. It is also suitable for contact with food and the application of foam, and can be used for cleaning equipment - all for a very good price-performance ratio.



	Max. tank diameter[m]	0	1	2	3	4	5	6	7	8	9
--	------------------------------	---	---	---	---	---	---	---	---	---	---



Material
PVDF



Max. temperature
90 °C



Recommended operating pressure
2 bar



Installation
Operation in every direction is possible



Filtration
Line strainer with a mesh size of 0.3 mm/50 mesh



Bearing
Slide bearing made of PVDF

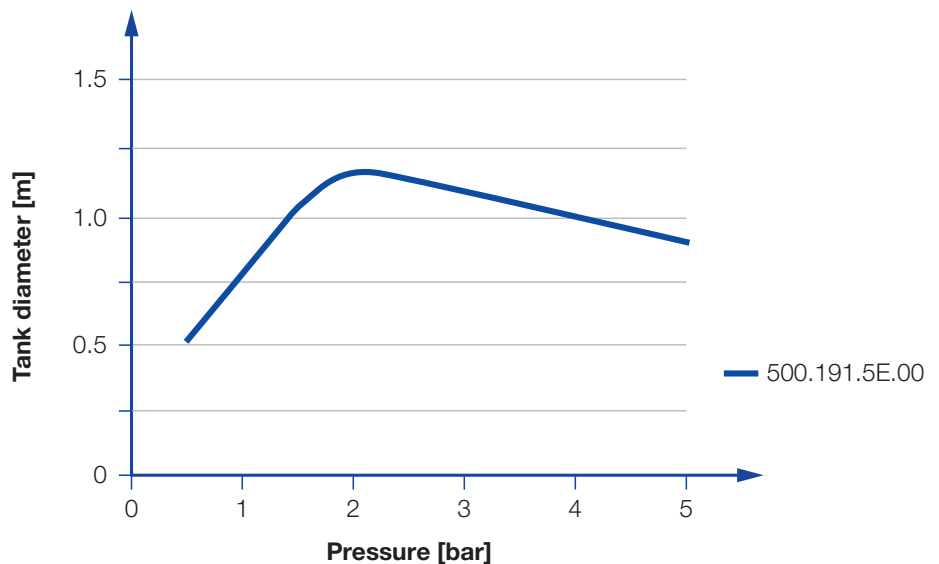

Overview of the tank diameter, depending upon the pressure of series 500.191

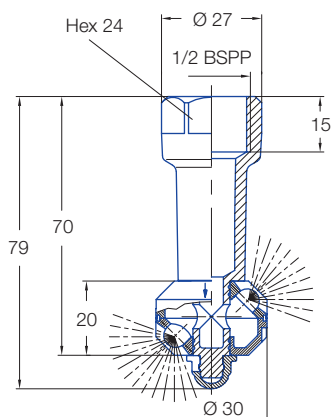



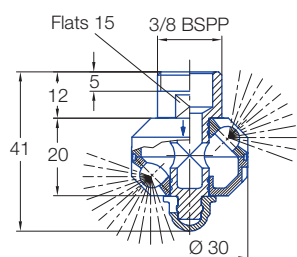

Standard version



Compact version



Standard version

Spray angle 	Ordering number Type	E Ø [mm]	Connection BSPP female	V̇ [l/min]				Max. tank diameter [m]
				p [bar] (p _{max} = 5 bar)				
				1	2	3	at 40 psi [US gal./ min]	
180° 	500.191.5E.02	2.2	1/2"	9	13	16	4	0.8
180° 	500.191.5E.01	2.2	1/2"	9	13	16	4	0.8
270° 	500.191.5E.41	2.2	1/2"	14	20	25	6	1.1
360° 	500.191.5E.00	2.2	1/2"	14	20	25	6	1.1

E = Narrowest free cross-section

The maximum tank diameter shown above applies for the recommended operating pressure and is indicative only. The cleaning result is also affected by the type of soiling.

Compact version

Spray angle 	Ordering number Type	E Ø [mm]	Connection BSPP male	V̇ [l/min]				Max. tank diameter [m]
				p [bar] (p _{max} = 5 bar)				
				1	2	3	at 40 psi [US gal./ min]	
180° 	500.191.5E.21	2.2	3/8"	9	13	16	4	0.8
360° 	500.191.5E.22	2.2	3/8"	14	20	25	6	1.1

E = Narrowest free cross-section

The maximum tank diameter shown above applies for the recommended operating pressure and is indicative only. The cleaning result is also affected by the type of soiling.

Information on operation

- Operation with compressed air only for short-term usage. Operation above the recommended operating pressure means higher wear and smaller droplets. This might have adverse effects on the cleaning result.



Rotating cleaning nozzle »NanoSpinner« Series 5NA

NEW

Series 5NA

The NanoSpinner convinces by its compact design which allows the cleaning in confined spaces. In addition, the rotating cleaning nozzle is characterized by a popular design and its double ball bearing. It is made entirely from stainless steel and designed for use also at high temperatures.



Function video

Scan the QR-code
or go to:
[www.lechler.de/
NanoSpinnerGB](http://www.lechler.de/NanoSpinnerGB)



Max. tank diameter [m]

0 | 1 | 2 | 3 | 4 | 5 | 6 | 7 | 8 | 9



Material

Stainless steel
AISI 316L,
Stainless steel
AISI 440C



Max. temperature

140 °C



Recommended operating pressure

2 bar



Installation

Operation in every
direction is possible



Filtration

Line strainer with
a mesh size of
0.1mm/170 Mesh



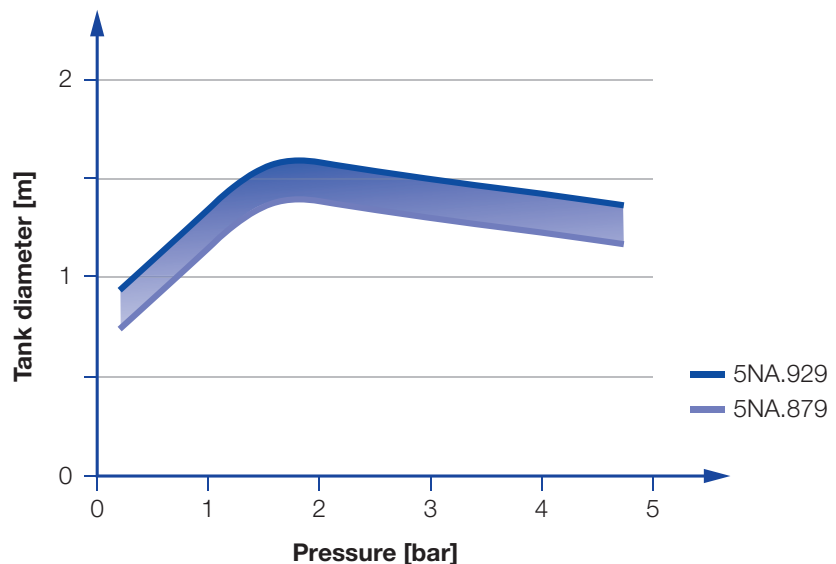

Bearing

Double ball bearing
made of AISI 440C

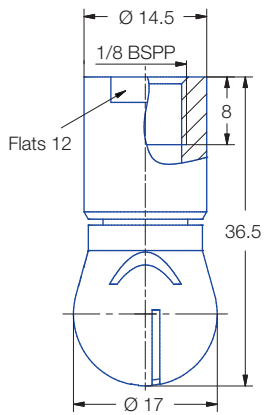

Overview of the tank diameter, depending upon the pressure of series 5NA



Spray angle 	Ordering number Type	E Ø [mm]	V̇ [l/min]				Max. tank diameter [m]
			p [bar] (p _{max} = 5 bar)				
			1	2	3	at 40 psi [US gal./ min]	
 360°	5NA.879.1Y.AB	0.5	11	15	18	5	1.4
	5NA.929.1Y.AB	0.5	14	20	25	6	1.6

E = Narrowest free cross-section

The maximum tank diameter shown above applies for the recommended operating pressure and is indicative only. The cleaning result is also affected by the type of soiling.

Information on operation

- Operation with compressed air only for short-term usage. Operation above the recommended operating pressure means higher wear and smaller droplets. This might have adverse effects on the cleaning result.



Rotating cleaning nozzle »MicroSpinner« Series 5MC

Series 5MC

The innovative slot design gives the MicroSpinner its high degree of effectiveness. Due to the modern bearing construction, it is particularly reliable and durable. The MicroSpinner is made entirely from stainless steel and designed for use also at high temperatures. Apart from stainless steel, it is also available in Hastelloy and in many flow rates.



Max. tank diameter [m]

0 | 1 | 2 | 3 | 4 | 5 | 6 | 7 | 8 | 9



Materials

Stainless steel
AISI 316L,
Stainless steel
AISI 440C
Hastelloy C22,
Hastelloy C276



Max. temperature

140 °C



Recommended operating pressure

2 bar



Installation

Operation in every direction is possible



Filtration

Line strainer with a mesh size of 0.1 mm/170 Mesh



Bearing

Double ball bearing made of AISI 440C
Double ball bearing made of C276

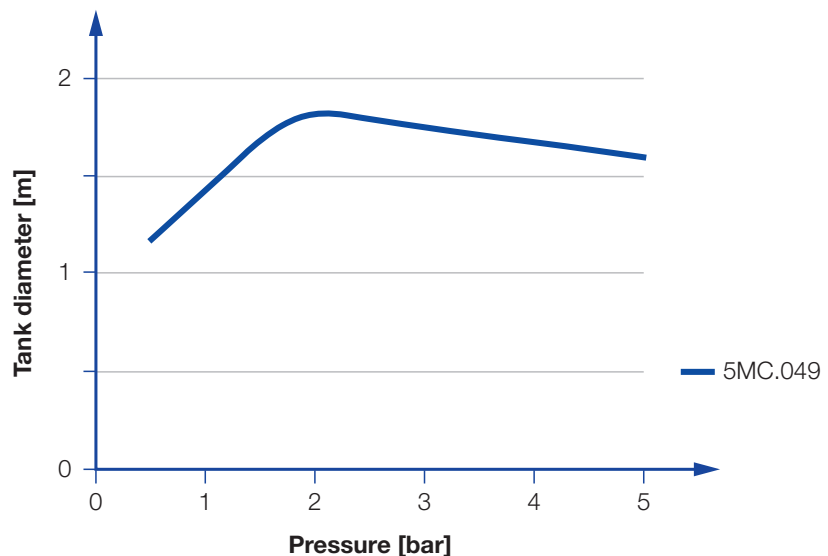

Overview of the tank diameter, depending upon the pressure of series 5MC

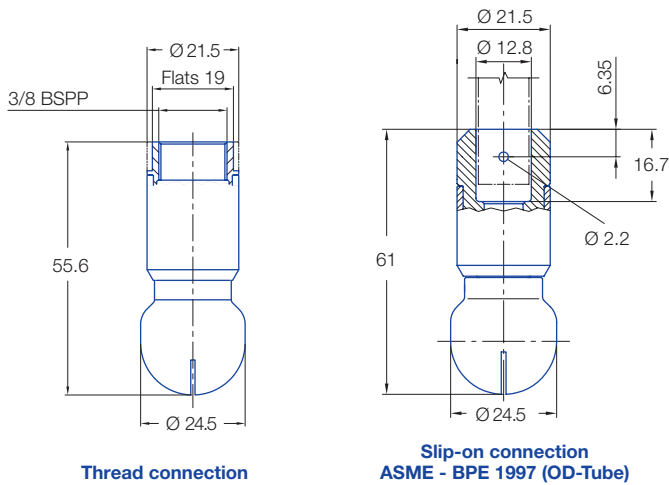

Thread connection

Slip-on connection
ASME - BPE 1997 (OD-Tube)

Spray angle	Ordering number					E Ø [mm]	V̇ [l/min]				Max. tank diameter [m]
	Type	Mat. no.		Connection*			p [bar] (p _{max} = 5 bar)				
		1Y AISI 316L	21** Hastelloy C22	3/8 BSPP	1/2" Slip-on		1	2	3	at 40 psi [US gal./min]	
60°	5MC.042	○	○	AF	TF05	3.0	28	40	49	12	-
180°	5MC.004	○	○	AF	TF05	0.8	22	32	39	10	1.8
360°	5MC.049	○	○	AF	TF05	0.9	28	39	48	12	1.8

E = Narrowest free cross-section

*NPT, more slip-on sizes and weld-on versions on request

**Material no. 21 (Hastelloy C22) not FDA and (EG) 1935/2004 conform

The maximum tank diameter shown above applies for the recommended operating pressure and is indicative only. The cleaning result is also affected by the type of soiling.

Information on operation

- Operation with compressed air only for short-term usage. Operation above the recommended operating pressure means higher wear and smaller droplets. This might have adverse effects on the cleaning result.

Example Type + Material no. + Connection = Ordering no.
of ordering: 5MC.042. + 1Y + AF = 5MC.042.1Y.AF

Slip-on information

- R-clip is included.
Mat. no. 1Y: R-clip made of stainless steel AISI 316L (Ordering no. 095.013.1E.05.59).
Mat. no. 21: R-clip made of Hastelloy C22 (Ordering no. 095.013.21.06.03)
- Depending on diameter of the adapter the flow rate can increase due to leakage between connecting pipe and rotating cleaning nozzle.



Rotating cleaning nozzle »MiniSpinner« Series 5MI

Series 5MI

The innovative slot design gives the MiniSpinner its high degree of effectiveness. Due to the modern bearing construction, it is particularly reliable and durable. The MiniSpinner is made entirely from stainless steel and designed for use also at high temperatures. Apart from stainless steel, it is also available in Hastelloy and in many flow rates.



Max. tank diameter [m]



Materials

Stainless steel
AISI 316L,
Stainless steel
AISI 440C
Hastelloy C22,
Hastelloy C276



Max. temperature
140 °C



Recommended operating pressure
2 bar



Installation
Operation in every direction is possible



Filtration
Line strainer with a mesh size of 0.1 mm/170 Mesh



Bearing
Double ball bearing made of AISI 440C
Double ball bearing made of C276

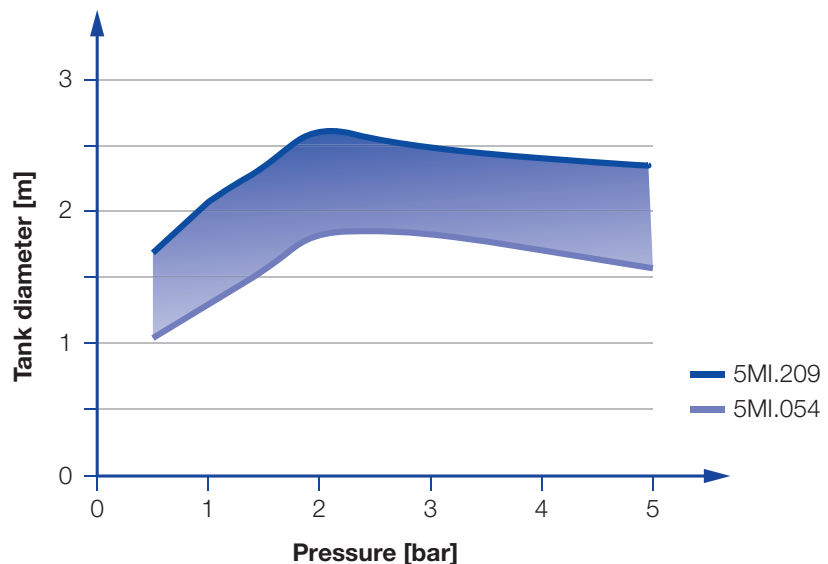



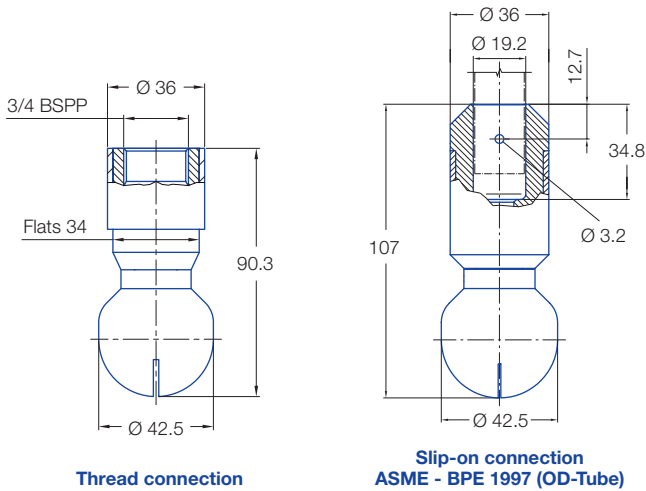

Overview of the tank diameter, depending upon the pressure of series 5MI



Thread connection

Slip-on connection
ASME - BPE 1997 (OD-Tube)

Spray angle 	Ordering no.					E Ø [mm]	V̇ [l/min]				Max. tank diameter [m]	
	Type	Mat. no.		Connection*			p [bar] (p _{max} = 5 bar)					
		1Y AISI 316L	21** Hastelloy C22	1/2 BSPP	3/4 BSPP		3/4" Slip-on	1	2	3		at 40 psi [US gal./ min]
60° 	5MI.162	○	○	AH	-	TF07	2.6	45	63	77	20	-
180° 	5MI.114	○	○	-	AL	TF07	1.0	47	67	82	21	2.6
360° 	5MI.054	○	○	-	AL	TF07	0.5	21	30	37	9	1.8
	5MI.074	○	○	-	AL	TF07	0.6	35	49	60	15	2.1
	5MI.014	○	○	-	AL	TF07	0.9	49	69	85	21	2.3
	5MI.209	○	○	-	AL	TF07	1.5	71	100	122	31	2.6

E = Narrowest free cross-section

*NPT, more slip-on sizes and weld-on versions on request

**Material no. 21 (Hastelloy C22) not FDA and (EG) 1935/2004 conform

The maximum tank diameter shown above applies for the recommended operating pressure and is indicative only. The cleaning result is also affected by the type of soiling.

Information on operation

- Operation with compressed air only for short-term usage. Operation above the recommended operating pressure means higher wear and smaller droplets. This might have adverse effects on the cleaning result.

Example Type + Material no. + Connection = Ordering no.
of ordering: 5MI.162. + 1Y + AH = 5MI.162.1Y.AH

Slip-on information

- R-clip is included.
Mat. no. 1Y: R-clip made of stainless steel AISI 316L (Ordering no. 095.022.1Y.50.60).
Mat. no. 21: R-clip made of Hastelloy C22 (Ordering no. 095.022.21.50.60)
- Depending on diameter of the adapter the flow rate can increase due to leakage between connecting pipe and rotating cleaning nozzle.



Rotating cleaning nozzles »Teflon® Whirly« Series 573 / 583

Series 573 / 583

The Teflon® Whirly is of particular interest for applications in the chemical, pharmaceutical and food industries. It works with rotating solid jets and is suitable for use in corrosive environments. The slip-on connection has a 3A® certification and can be used in areas subject to particularly high hygiene requirements, such as contact with food.



Function video

Scan the QR-code
or go to:
[www.lechler.de/
TeflonWhirlyGB](http://www.lechler.de/TeflonWhirlyGB)



Max. tank diameter [m]

0 | 1 | 2 | 3 | 4 | 5 | 6 | 7 | 8 | 9



Material
PTFE (Teflon®)



Max. temperature
95 °C (Versions for use with higher temperature on request)



Recommended operating pressure
2 bar



Installation
Operation in every direction is possible



Filtration
Line strainer with a mesh size of 0.3 mm/50 Mesh



Bearing
Slide bearing made of PTFE

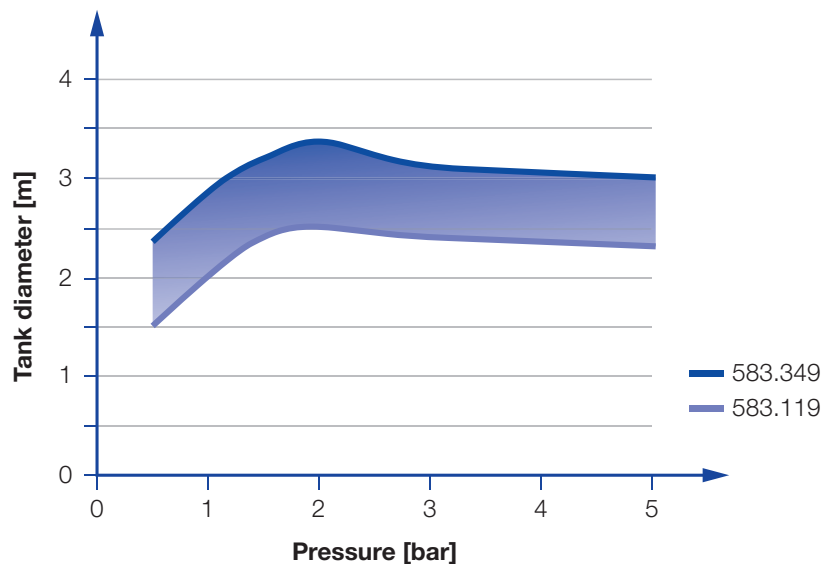

Overview of the tank diameter, depending upon the pressure of series 573 / 583

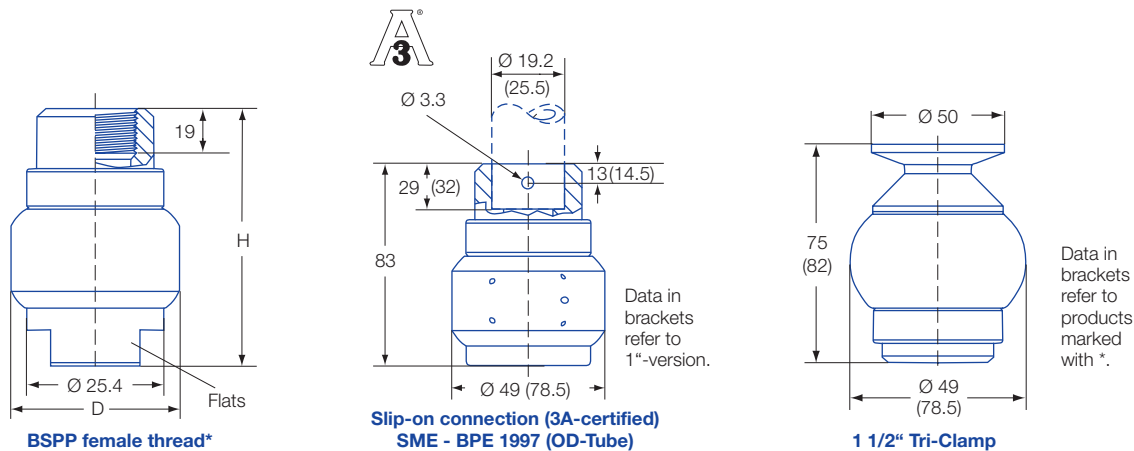

Data in brackets refer to products marked with *.

Spray angle	R-clip	Ordering no.						E Ø [mm]	V̇ [l/min]				Dimensions for female thread version		Max. tank diameter [m]
		Type	Connection						p [bar] (p _{max} = 6 bar)				Height H [mm]	Diameter D [mm]	
			3/4 BSPP	1 BSPP	3/4" Slip-on	1" Slip-on	1 1/2" Tri-Clamp		1	2	3	at 40 psi [US gal./min]			
180°	1)	583.114.55	AL	-	TF07	TF10	15	2.1	47	67	82	21	74	49	2.5
	1)	583.264.55	AL	-	TF07	TF10	15	3.3	103	145	178	45	74	49	2.8
	2)	583.344.55	-	AN	-	TF10	15*	7.1	159	225	276	70	100	78.5	3.2
180°	1)	573.114.55	AL	-	TF07	TF10	15	2.1	47	67	82	21	74	49	2.5
	1)	573.264.55	AL	-	TF07	TF10	15	3.3	103	145	178	45	74	49	2.8
	2)	573.344.55	-	AN	-	TF10	15*	7.1	159	225	276	70	100	78.5	3.2
270°	1)	583.116.55	AL	-	TF07	TF10	15	2.4	47	67	82	21	74	49	2.5
	1)	583.266.55	AL	-	TF07	TF10	15	3.4	103	145	178	45	74	49	2.8
	2)	583.346.55	-	AN	-	TF10	15*	5.9	159	225	276	70	100	78.5	3.2
270°	1)	573.116.55	AL	-	TF07	TF10	15	2.4	47	67	82	21	74	49	2.5
	1)	573.266.55	AL	-	TF07	TF10	15	3.4	103	145	178	45	74	49	2.8
	2)	573.346.55	-	AN	-	TF10	15*	5.9	159	225	276	70	100	78.5	3.2
360°	1)	583.119.55	AL	-	TF07	TF10	15	1.8	47	67	82	21	74	49	2.4
	1)	583.209.55	AL	-	TF07	TF10	15	3.5	71	100	122	31	74	49	2.5
	1)	583.269.55	AL	-	TF07	TF10	15	4.8	103	145	178	45	74	49	2.8
	2)	583.279.55	-	AN	-	TF10	15*	3.7	106	150	184	47	100	78.5	3.0
	2)	583.349.55	-	AN	-	TF10	15*	5.6	159	225	276	70	100	78.5	3.2

E = Narrowest free cross-section · NPT on request

The maximum tank diameter shown above applies for the recommended operating pressure and is indicative only. The cleaning result is also affected by the type of soiling.

Information on operation

- Operation with compressed air only for short-term usage. Operation above the recommended operating pressure means higher wear and smaller droplets. This might have adverse effects on the cleaning result. Teflon® is a registered trademark of E. I. Dupont De Nemours and Company.

Slip-on information

- R-clip made of stainless steel AISI 316 L is included (Ordering no.: R-clip 1: 095.022.1Y.50.88.E, R-clip 2: 095.022.1Y.50.60.E).
- Depending on diameter of the adapter the flow rate can increase due to leakage between connecting pipe and rotating cleaning nozzle.

Example of ordering:	Type	+	Connection	=	Ordering no.
	583.114.55.	+	AL	=	583.114.55.AL



Rotating cleaning nozzles »Gyro« Series 577

NEW

Series 577

The Gyro cleans with powerful nozzle inserts and is available in many flow rates and spray angles. It is also suitable for very large tanks and is insensitive to clogging.

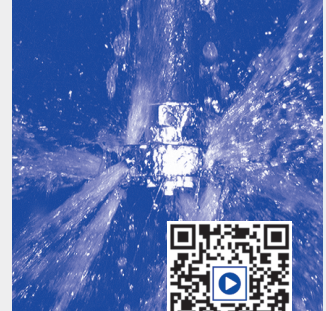
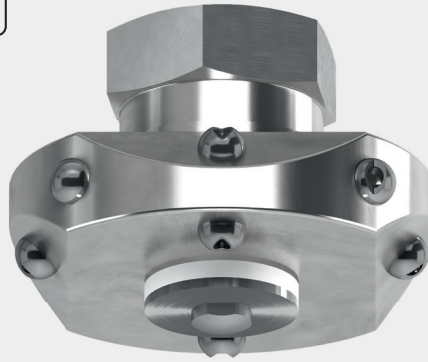

Function video

Scan the QR-code
or go to:
[www.lechler.de/
GyroGB](http://www.lechler.de/GyroGB)



Max. tank diameter [m]

0 | 1 | 2 | 3 | 4 | 5 | 6 | 7 | 8 | 9



Materials

Stainless steel
AISI 316L, PTFE



Max. temperature

90 °C



Recommended operating pressure

3 bar



Installation

Vertically facing downward



Filtration

Line strainer with a mesh size of 0.3 mm/50 mesh



Bearing

Slide bearing made of PTFE







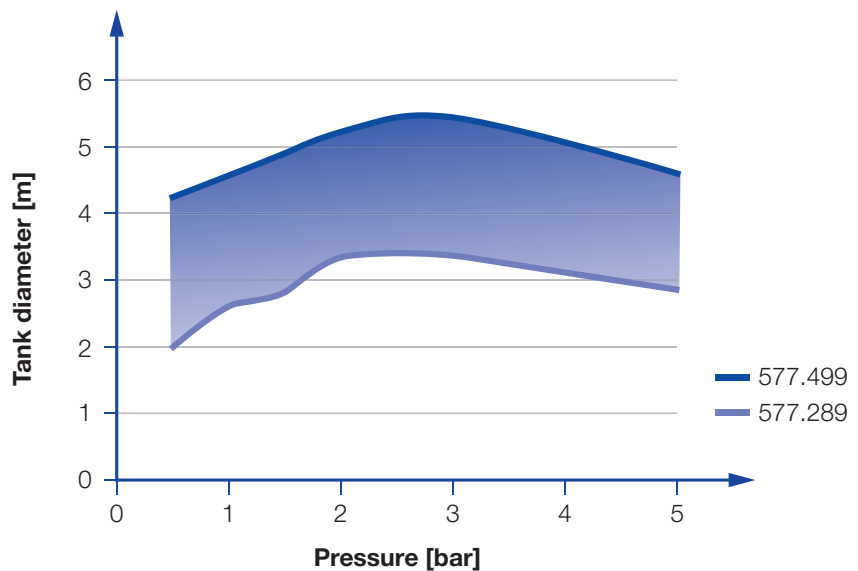

Accessories

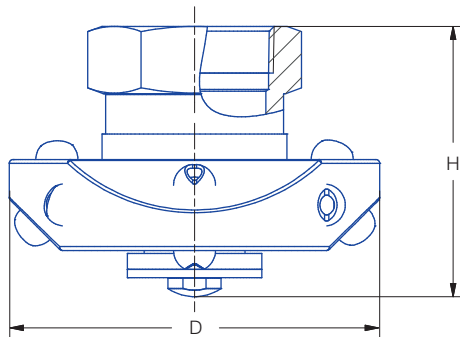
Spare parts set consisting of:
top seal, bottom seal, bolt, nut, sleeve, instructions for use



Overview of the tank diameter, depending upon the pressure of series 577



Spray angle 	Ordering no.			V [l/min]					Dimensions	
	Type	Connection		p [bar] (p _{max} = 5 bar)					Height H [mm]	Diameter D [mm]
		NPT 1"	NPT 2"	1	2	3	5	at 40 psi [US gal./min]		
180° 	577.283.1Y	BN	-	115	163	200	258	50	72	118
	577.363.1Y	BN	-	182	258	316	408	80	72	118
	577.403.1Y	-	BW	228	322	394	509	100	103	156
	577.433.1Y	-	BW	273	386	473	610	120	103	156
	577.523.1Y	-	BW	452	639	783	1010	170	103	156
180° 	577.284.1Y	BN	-	115	163	200	258	50	72	118
	577.364.1Y	BN	-	182	258	316	408	80	72	118
	577.404.1Y	-	BW	228	322	394	509	100	103	156
	577.434.1Y	-	BW	273	386	473	610	120	103	156
	577.494.1Y	-	BW	380	538	659	851	170	103	156
270° 	577.285.1Y	BN	-	115	163	200	258	50	72	118
	577.365.1Y	BN	-	182	258	316	408	80	72	118
	577.405.1Y	-	BW	228	322	394	509	100	103	156
	577.435.1Y	-	BW	273	386	473	610	120	103	156
	577.495.1Y	-	BW	380	538	659	851	170	103	156
360° 	577.289.1Y	BN	-	115	163	200	258	50	72	118
	577.369.1Y	BN	-	182	258	316	408	80	72	118
	577.409.1Y	-	BW	228	322	394	509	100	103	156
	577.439.1Y	-	BW	273	386	473	610	120	103	156
	577.499.1Y	-	BW	380	538	659	851	170	103	156

The maximum tank diameter shown above applies for the recommended operating pressure and is indicative only. The cleaning result is also affected by the type of soiling.

Information on operation

- Operation with compressed air only for short-term usage. Operation above the recommended operating pressure means higher wear and smaller droplets. This might have adverse effects on the cleaning result.

Example for Ordering:	Type	+	Connection	=	Ordering no.
	577.283.1Y.	+	BN	=	577.283.1Y.BN



Pop-up rotating cleaning nozzles »PopUp Whirly« Series 500.382 / 500.453

Series 500.382 / 500.453

When a certain fluid pressure is reached, the rotating cleaning nozzle of PopUp Whirly is automatically extended from the enclosure. These free-spinning rotating nozzles can be installed flush in the tank wall. They are also suitable for cleaning pipes and for applications that use foam. They are of particular interest for applications in the food and beverage industry as well as for the pharmaceutical and chemical industry.



Function video

Scan the QR-code
or go to:
[www.lechler.de/
PopupWhirlyGB](http://www.lechler.de/PopupWhirlyGB)



Max. tank diameter [m]

0 | 1 | 2 | 3 | 4 | 5 | 6 | 7 | 8 | 9



Materials

Stainless steel AISI 316L, stainless steel AISI 301 (spring), PEEK (slide bearing), FKM (O-Ring 500.453.1Y.00), EPDM (O-Ring 500.382.1E.06)



Max. temperature

140 °C



Recommended operating pressure

2 bar, opening pressure approx. 0.8 bar



Installation

Operation in every direction is possible



Filtration

Line strainer with a mesh size of 0.3 mm/50 Mesh



Bearing

Slide bearing made of PEEK

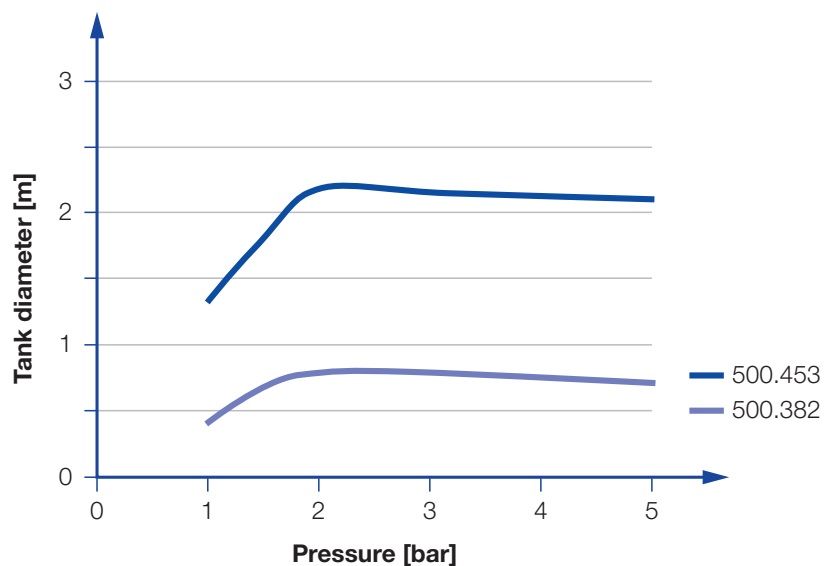

Overview of the tank diameter, depending upon the pressure of series 500.382 / 500.453

Series 500.382

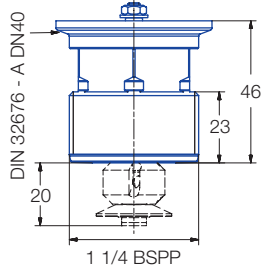

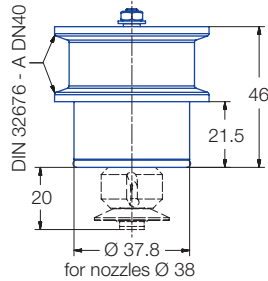

Male thread

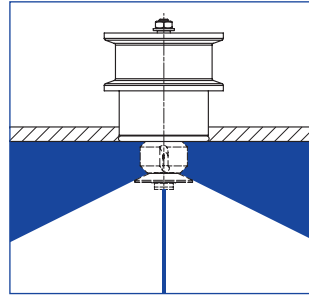

Tri-Clamp



Spray angle 	Ordering no.	Tank connection		E Ø [mm]	V̇ [l/min]				Max. tank diameter [m]
		1 1/4 BSPP	Tri-Clamp		p [bar] (p _{max} = 6 bar)				
					1	2	3	at 40 psi [US gal./ min]	
	500.382.1E.02	○	-	1.1	7.6	10.8	13.2	3.4	0.8
	500.382.1E.06	-	○	1.1	7.6	10.8	13.2	3.4	0.8

The maximum tank diameter shown above applies for the recommended operating pressure and is indicative only. The cleaning result is also affected by the type of soiling.

Series 500.453

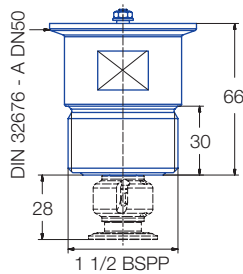

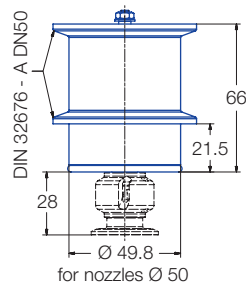

Male thread

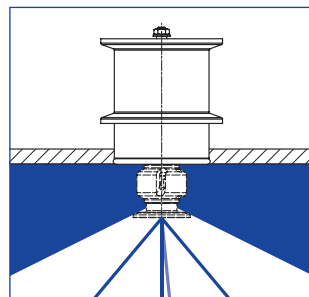

Tri-Clamp



Spray angle 	Ordering no.	Tank connection		E Ø [mm]	V̇ [l/min]				Max. tank diameter [m]
		1 1/2 BSPP	Tri-Clamp		p [bar] (p _{max} = 6 bar)				
					1	2	3	at 40 psi [US gal./ min]	
	500.453.1Y.AR	○	-	1.2	28.3	40	49	12.4	2.2
	500.453.1Y.00	-	○	1.2	28.3	40	49	12.4	2.2

The maximum tank diameter shown above applies for the recommended operating pressure and is indicative only. The cleaning result is also affected by the type of soiling.

Nozzle installation

Via thread in idle position

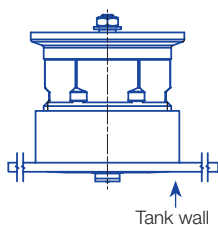

Tank wall

Via Tri-Clamp in operating position

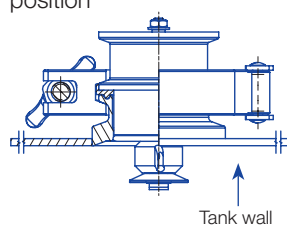

Tank wall

Information on operation

- Operation with compressed air only for short-term usage. Operation above the recommended operating pressure means higher wear and smaller droplets. This might have adverse effects on the cleaning result.

EFFICIENT REMOVAL OF LIGHT AND MEDIUM SOILING

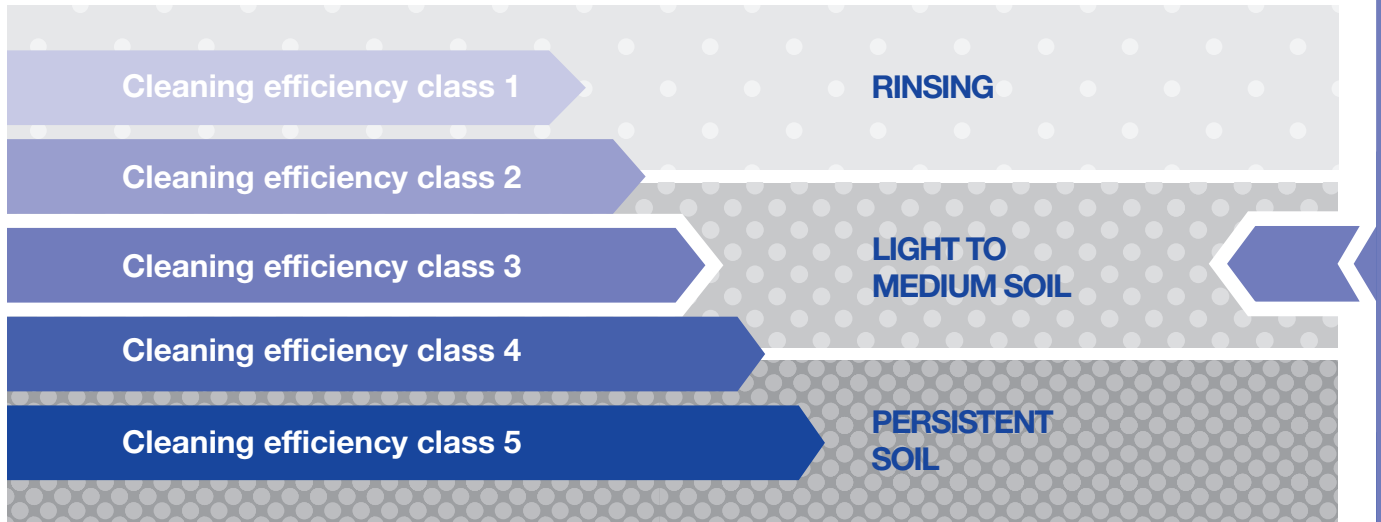

Cleaning efficiency class 3

Due to their special nozzle geometry and flow rates from 11 to 145 l/min at 2 bar, the rotating nozzles in efficiency class 3 are suitable for cleaning medium soiling from tanks and equipment. Such soiling is especially found in the food and beverage industry, but also in the chemical and pharmaceutical industry. The free-spinning rotating nozzles in class 3 are made from especially high-grade materials, are available in tank sizes from small to large, and

are also suitable for CIP-cleaning (Cleaning in Place). The EHEDG-certified HygienicWhirly is perfectly suited for hygienically sensitive areas and can also be used for the output of foam.

The Whirly series is also available as an ATEX version and can therefore also be used in explosive environments.

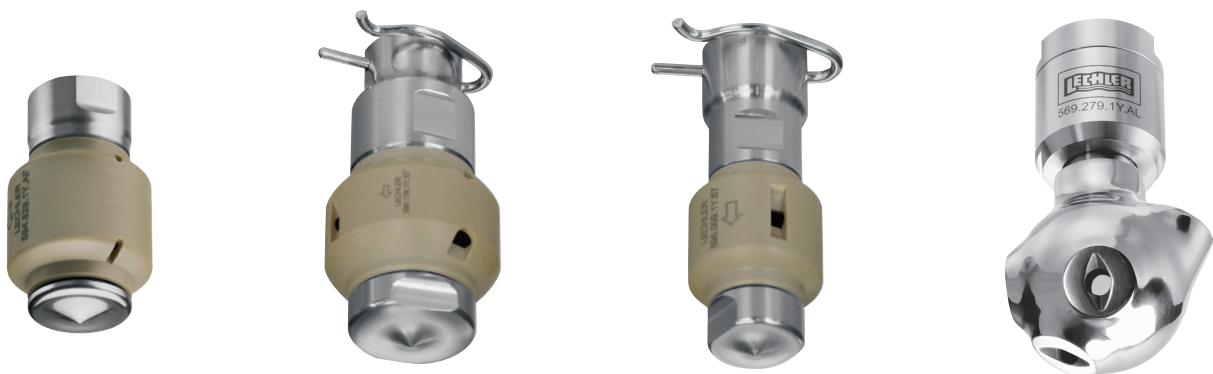

	Max. tank diameter [m]	0	1	2	3	4	5	6	7	8
---	-------------------------------	---	---	---	---	---	---	---	---	---

 **Operating principles**
Free-spinning

 **Flow rates at 2 bar**
11 to 145 l/min

 **Recommended operating pressures**
2 to 3 bar

 **Max. temperatures**
100 to 140 °C



Rotating cleaning nozzles »HygienicWhirly« Series 594 / 595

Series 594 / 595

The HygienicWhirly with its highly effective flat jets is particularly suited for high hygiene requirements and for the application of foam. It is available in an EHEDG-version and can be used to clean tanks and equipment. Operation at low pressure with good cleaning effect is also possible.



Max. tank diameter [m]



Materials

Stainless steel
AISI 316L, PEEK,
EHEDG-version:
O-ring made
of EPDM



Max. temperature

100 °C,
short-term
up to 140 °C



Recommended operating pressure

3 bar



Installation

Operation in every
direction is possible



Filtration

Line strainer with
a mesh size of
0.3 mm/50 Mesh



Bearing

Slide bearing
made of PEEK

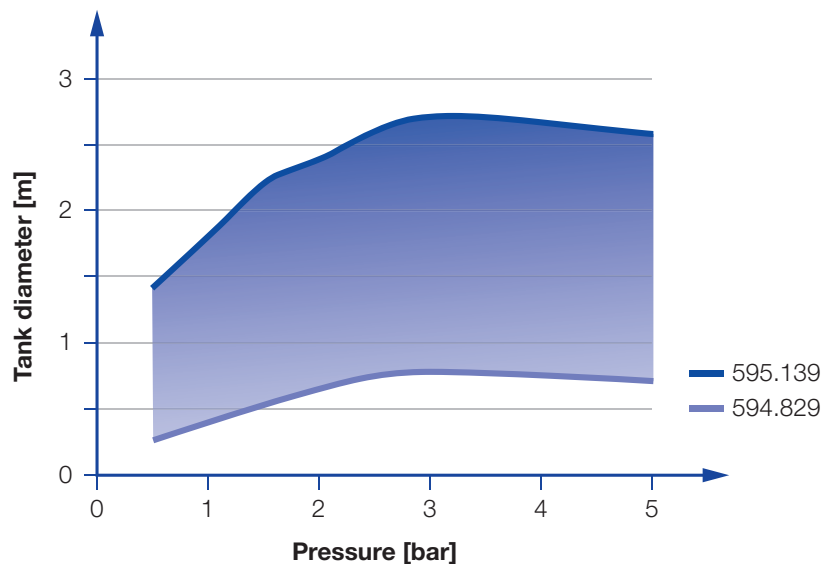

Overview of the tank diameter, depending upon the pressure of series 594 / 595

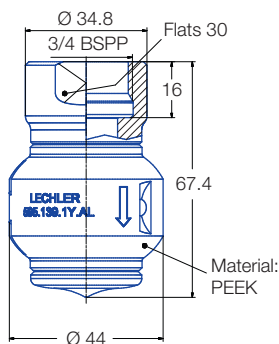

**Standard version
female tread
595.139.1Y.AL**

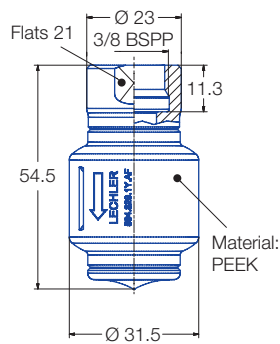

**Standard version
female tread
594.XX9.1Y.AF**

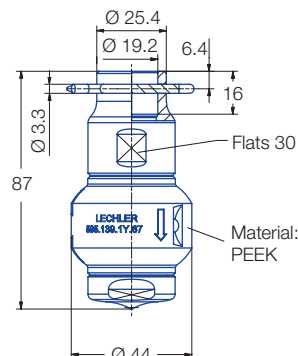

**EHEDG-version
Slip-on connection ASME - BPE 1997
(OD-Tube) 595.139.1Y.67**

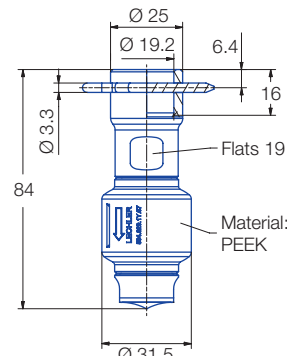

**EHEDG-version
Slip-on connection ASME - BPE 1997
(OD-Tube) 594.XX9.1Y.67**

Spray angle	Ordering no.				E Ø [mm]	V̇ [l/min]					Max. tank diameter [m]
	Type	Connection				p [bar] (p _{max} = 5 bar)					
		3/8 BSPP* female	3/4 BSPP* female	3/4" Slip-on EHEDG version		0.5	1	2	3	at 40 psi [US gal./min]	
360°	594.829.1Y	AF	-	67	1.7	6	8	11	14	3	0.8
	594.879.1Y	AF	-	67	2.5	8	11	15	18	5	1.2
	595.009.1Y	AF	-	67	4.0	16	22	32	39	10	1.5
	595.049.1Y	AF	-	67	4.2	20	28	40	49	12	2.0
	595.139.1Y	-	AL	67	5.0	34	47	67	82	21	2.7

E = Narrowest free cross-section · *NPT on request

The maximum tank diameter shown above applies for the recommended operating pressure and is indicative only. The cleaning result is also affected by the type of soiling.

Information on operation

- Operation with compressed air only for short-term usage. Operation above the recommended operating pressure means higher wear and smaller droplets. This might have adverse effects on the cleaning result.

Example of ordering:	Type	+	Connection	=	Ordering no.
	594.829.1Y	+	AF	=	594.829.1Y.AF

Slip-on information

- R-clip made of stainless steel AISI 316L is included (Ordering no.: 095.022.1Y.50.94.E).
- Depending on diameter of the adapter the flow rate can increase due to leakage between connecting pipe and rotating cleaning nozzle.



Rotating cleaning nozzle »Whirly« Series 569

Series 569

Popular and proven: the design of the Whirly. It generates effective flat jets, offers various connection options and is available in a very wide range of flow rates. It is also available in an ATEX-approved version and in a range of versions with different spray angles.

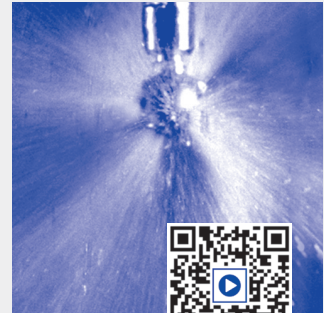

Function video

Scan the QR-code
or go to:
www.lechler.de/WhirlyGB



Max. tank diameter [m]



Materials

Stainless steel
AISI 316L, PEEK,
Rulon 641



Max. temperature

140 °C
90 °C ATEX version



Recommended operating pressure

2 bar



Installation

Operation in every direction is possible; in horizontal installation position no rotating until 2 bar, ATEX version only vertical use



Filtration

Line strainer with a mesh size of 0.1 mm / 170 Mesh



Bearing

Double ball bearing made of stainless steel

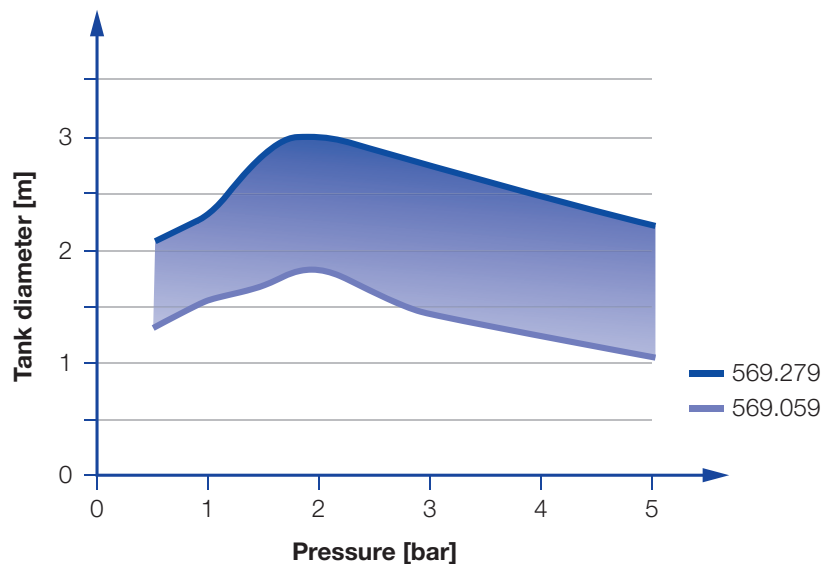

Overview of the tank diameter, depending upon the pressure of series 569

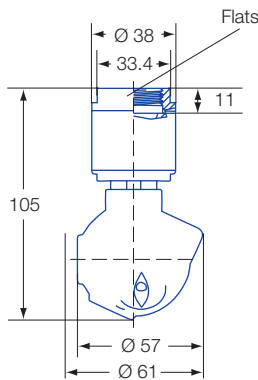



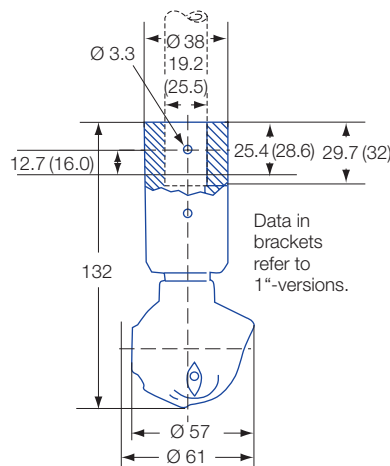

3/4 BSPP female thread

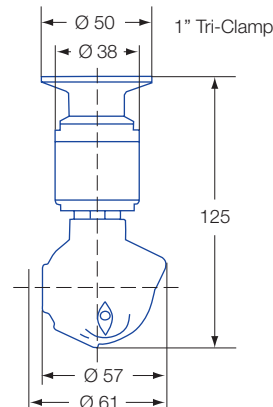

Slip-on connection
ASME - BPE 1997 (OD-Tube)



1" Tri-Clamp

Spray angle 	Ordering no.					E Ø [mm]	V̇ [l/min]				Max. tank diameter [m]
	Type	Connection					p [bar] (p _{max} = 6 bar)				
		3/4 BSPP* female	3/4" Slip-on	1" Slip-on	1" Tri-Clamp		1	2	3	at 40 psi [US gal./min]	
270° 	569.055.1Y	AL	TF07	TF10	10	3.6	36	48	62	15	1.8
	569.135.1Y	AL	TF07	TF10	10	4.8	52	71	87	22	2.1
	569.195.1Y	AL	TF07	TF10	10	5.6	69	97	119	30	2.6
270° 	569.056.1Y	AL	TF07	TF10	10	3.6	36	48	62	15	1.8
	569.106.1Y	AL	TF07	TF10	10	4.8	41	58	71	18	2.1
	569.196.1Y	AL	TF07	TF10	10	5.6	69	97	119	30	2.6
360° 	569.059.1Y	AL	TF07	TF10	10	3.2	36	48	62	15	1.8
	569.139.1Y	AL	TF07	TF10	10	3.6	52	71	87	22	2.1
	569.199.1Y	AL	TF07	TF10	10	4.8	69	97	119	30	2.6
	569.279.1Y	AL	TF07	TF10	10	7.1	103	145	178	45	3.0

E = Narrowest free cross-section · *NPT on request

The maximum tank diameter shown above applies for the recommended operating pressure and is indicative only. The cleaning result is also affected by the type of soiling.

Information on operation

- Operation with compressed air only for short-term usage. Operation above the recommended operating pressure means higher wear and smaller droplets. This might have adverse effects on the cleaning result.

Slip-on information

- R-clip made of stainless steel AISI 316L is included (Ordering no.: 095.022.1Y.50.60.E).
- Depending on diameter of the adapter the flow rate can increase due to leakage between connecting pipe and rotating cleaning nozzle.

Example of ordering with ATEX-approval.
FDA and (EG) 1935/2004 conform.
Only 3/4 thread connection and 3/4" Slip-on connection available with ATEX-approval.



Unit group / category / zones:

II 1 GD c IIB T4 T 120 °C +5 °C ≤ Ta ≤ +90 °C
for zone 0, 1, 2 (gas atmosphere)
for zone 20, 21, 22 (dust atmosphere)



Example Type + Connection = Ordering no.
of Ordering: 569.055.1Y.XX.EX + AL = 569.055.1Y.AL.EX

Example of ordering with FDA and (EG) 1935/2004 conformity.



All Materials are suitable for contact with food.

Example Type + Connection = Ordering no.
of Ordering: 569.103.1Y.XX + AL = 569.103.1Y.AL

EFFECTIVE REMOVAL OF HEAVY SOILING

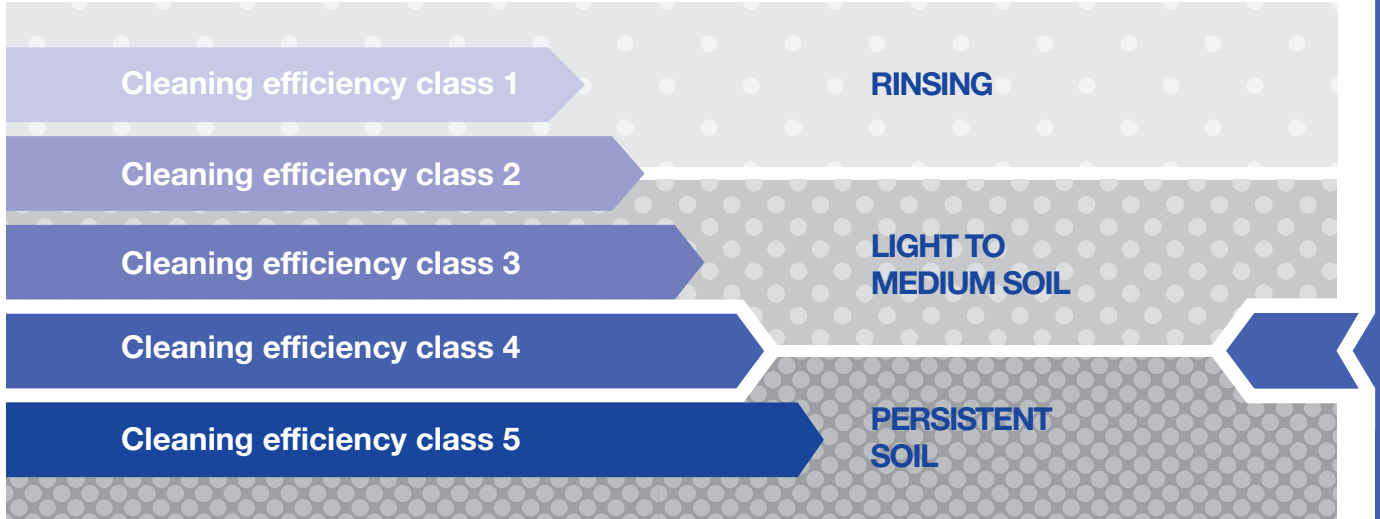

Cleaning efficiency class 4

The Lechler products in this class have controlled rotating cleaning nozzles. They are suitable for contact with food, the cleaning of large tanks and for use in combination with the Lechler rotation monitoring sensor. The cleaning nozzles of cleaning efficiency class 4 are available in many different sizes and flow rates.

The efficient flat spray nozzle geometry of the rotating cleaners in cleaning efficiency class 4 ensures the removal of heavy soiling at temperatures of up to 140 °C.



 **Operating principles**
Controlled rotation

 **Flow rates at 2 bar**
15 to 193 l/min

 **Recommended operating pressures**
3 to 5 bar

 **Max. temperatures**
80 to 140 °C



Rotating cleaning nozzle »XactClean®« Series 5W2 / 5W3

Series 5W2 / 5W3

The XactClean® works extremely efficiently thanks to the controlled rotation. It can also be used for higher pressures, is compatible with the Lechler rotation monitoring sensor, and licensed for contact with food. It is also available in many flow rates and with various spray angles.



Max. tank diameter [m]

0 | 2 | 4 | 6 | 8 | 10 | 12 | 14 | 16 | 18



Materials
Stainless steel
AISI 316L, PTFE



Max. temperature
80 °C



Recommended operating pressure
5 bar



Installation
Operation in every direction is possible



Filtration
Line strainer with a mesh size of 0.1 mm/170 Mesh



Bearing
Slide bearing made of PTFE



Rotation monitoring sensor
Sensor compatible
Info: see page 60

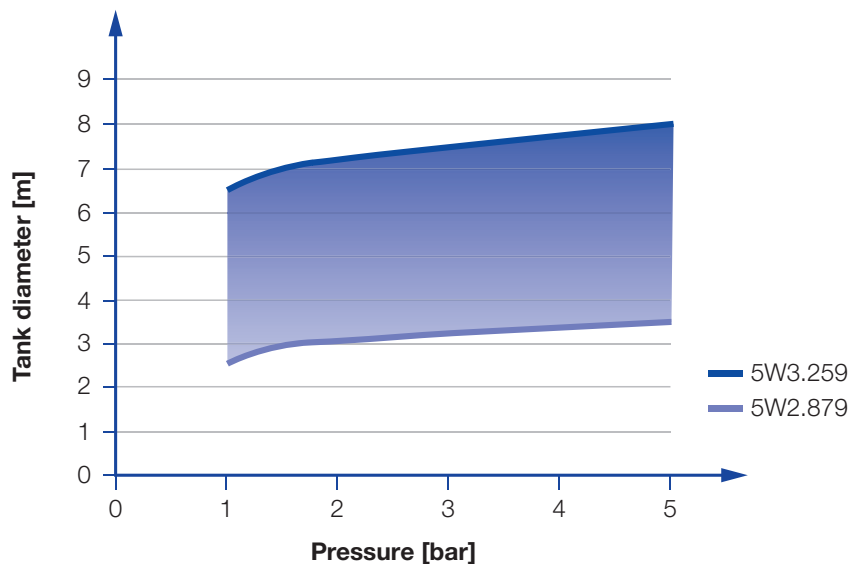

Overview of the tank diameter, depending upon the pressure of series 5W2 / 5W3

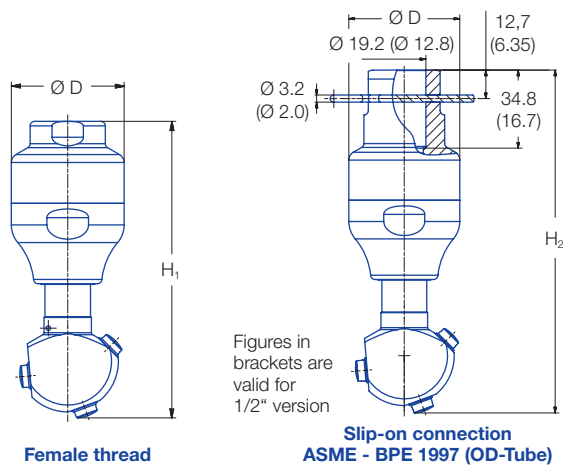

Nozzle dimensions [mm]

Type	H ₁ (Thread version)	H ₂ (Slip-on)	Ø D
5W2.87X	114	118	43
5W2.99X	114	118	43
5W3.06X	114	136	43
5W3.14X	146	167	60
5W3.20X	146	167	60
5W3.25X	146	167	60

Spray angle	Ordering no.							E Ø [mm]	V̇ [l/min]				Max. tank diameter [m]
	Type	Connection							p [bar] (p _{max} = 20 bar)				
		3/8 BSPP* female	1/2 BSPP* female	3/4 BSPP* female	1 BSPP* female	1/2" Slip-on	3/4" Slip-on		2	5	10	at 40 psi [US gal./min]	
270°	5W2.875.1Y	AF	AH	-	-	TF05	-	1.7	15	24	34	4.7	3.5
	5W2.995.1Y	-	AH	-	-	TF05	-	2.2	30	47	67	9.3	4.0
	5W3.065.1Y	-	AH	AL	-	-	TF07	2.2	42	66	94	13.0	6.0
	5W3.145.1Y	-	-	AL	-	-	TF07	3.8	70	111	157	21.7	7.0
	5W3.205.1Y	-	-	AL	-	-	TF07	4.8	100	158	224	31.0	7.5
	5W3.255.1Y	-	-	AL	AN	-	TF07	5.5	130	206	291	40.3	8.0
270°	5W2.876.1Y	AF	AH	-	-	TF05	-	1.7	15	24	34	4.7	3.5
	5W2.996.1Y	-	AH	-	-	TF05	-	2.2	30	47	67	9.3	4.0
	5W3.066.1Y	-	AH	AL	-	-	TF07	2.2	42	66	94	13.0	6.0
	5W3.146.1Y	-	-	AL	-	-	TF07	3.8	70	111	157	21.7	7.0
	5W3.206.1Y	-	-	AL	-	-	TF07	4.8	100	158	224	31.0	7.5
	5W3.256.1Y	-	-	AL	AN	-	TF07	5.5	130	206	291	40.3	8.0
360°	5W2.879.1Y	AF	AH	-	-	TF05	-	1.5	15	24	34	4.7	3.5
	5W2.999.1Y	-	AH	-	-	TF05	-	2.0	30	47	67	9.3	4.0
	5W3.069.1Y	-	AH	AL	-	-	TF07	2.0	42	66	94	13.0	6.0
	5W3.149.1Y	-	-	AL	-	-	TF07	3.5	70	111	157	21.7	7.0
	5W3.209.1Y	-	-	AL	-	-	TF07	4.4	100	158	224	31.0	7.5
	5W3.259.1Y	-	-	AL	AN	-	TF07	5.0	130	206	291	40.3	8.0

E = Narrowest free cross-section · *NPT on request

The maximum tank diameter shown above applies for the recommended operating pressure and is indicative only. The cleaning result is also affected by the type of soiling.

Information on operation

- Operation with compressed air only for short-term usage. Operation above the recommended operating pressure means higher wear and smaller droplets. This might have adverse effects on the cleaning result.

Slip-on information

- R-clip made of stainless steel AISI 316L is included (Ordering no.: 095.022.1Y.50.60.E (5W3), 095.013.1E.05.59.0 (5W2)).
- Depending on diameter of the adapter the flow rate can increase due to leakage between connecting pipe and rotating cleaning nozzle.

Example of ordering:	Type	+	Connection	=	Ordering no.
	5W2.875.1Y.	+	AF	=	5W2.875.1Y.AF



Rotating cleaning nozzle »XactClean® HP« Series 5S2 / 5S3

NEW

Series 5S2 / 5S3

Specially developed flat fan nozzles provide high impact and uniform cleaning for the XactClean® HP. The controlled rotation ensures that the XactClean® HP works extremely efficient. Thanks to the robust drive unit the XactClean® HP is very reliable and ensures increased operation liability. It is available in various spray angles and flow rates and is also compatible with the Lechler rotating monitoring sensor.



Function video

Scan the QR-code
or go to:
[www.lechler.de/
XactCleanHPGB](http://www.lechler.de/XactCleanHPGB)



Max. tank diameter [m]

0 | 2 | 4 | 6 | 8 | 10 | 12 | 14 | 16 | 18



Materials

Stainless steel
AISI 316L, stainless
steel AISI 316, PEEK,
PTFE, Zirconium
oxide, EPDM



Max. temperature

95 °C



Recommended operating pressure

5 bar



Installation

Operation in every
direction is possible



Filtration

Line strainer with
a mesh size of
0.3 mm/50 mesh



Bearing

Double ball bearing



Rotation monitoring sensor

Sensor compatible
Info: see page 60

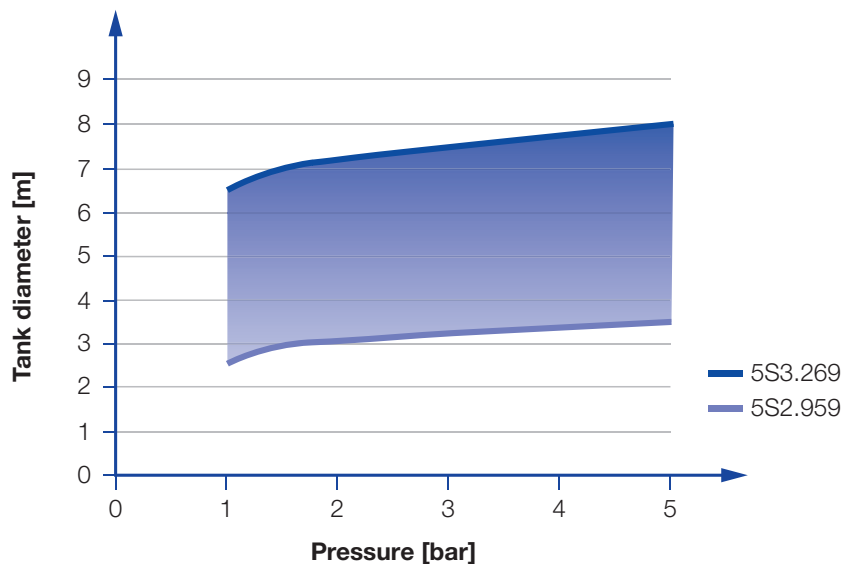

Overview of the tank diameter, depending upon the pressure of series 5S2 / 5S3

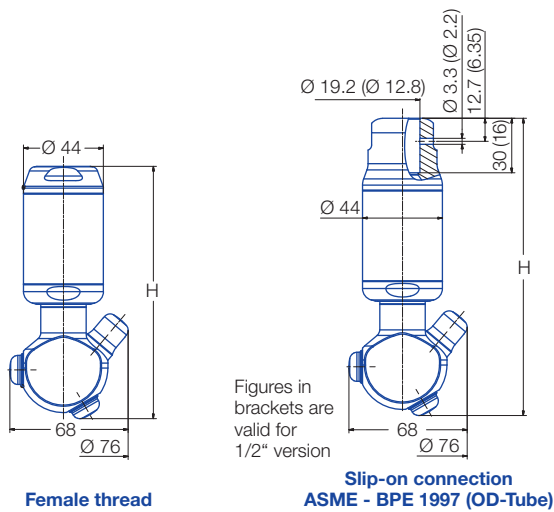

Nozzle dimensions [mm]

Connection	H
AF	148
AH	149
AL	139
AN	139
TF05	150
TF07	164

Spray angle	Ordering no.							E Ø [mm]	V̇ [l/min]				Max. tank diameter [m]
	Type	Connection							p [bar] (p _{max} = 15 bar)				
		3/8 BSPP* female	1/2 BSPP* female	3/4 BSPP* female	1 BSPP* female	1/2" Slip-on	3/4" Slip-on		2	5	10	at 40 psi [US gal./min]	
270°	5S2.955.1Y	AF	AH	-	-	TF05	-	2.0	25	40	57	7.8	3.5
	5S3.055.1Y	-	AH	-	-	TF05	-	2.0	41	65	92	12.8	4.0
	5S3.115.1Y	-	AH	AL	-	-	TF07	2.0	60	94	133	18.4	6.0
	5S3.185.1Y	-	-	AL	-	-	TF07	2.0	89	141	199	27.7	7.0
	5S3.235.1Y	-	-	AL	-	-	TF07	2.0	111	175	248	34.3	7.5
	5S3.265.1Y	-	-	AL	AN	-	TF07	2.0	135	213	301	41.8	8.0
270°	5S2.956.1Y	AF	AH	-	-	TF05	-	2.0	25	40	57	7.8	3.5
	5S3.056.1Y	-	AH	-	-	TF05	-	2.0	41	65	92	12.8	4.0
	5S3.116.1Y	-	AH	AL	-	-	TF07	2.0	60	94	133	18.4	6.0
	5S3.186.1Y	-	-	AL	-	-	TF07	2.0	89	141	199	27.7	7.0
	5S3.236.1Y	-	-	AL	-	-	TF07	2.0	111	175	248	34.3	7.5
	5S3.266.1Y	-	-	AL	AN	-	TF07	2.0	135	213	301	41.8	8.0
360°	5S2.959.1Y	AF	AH	-	-	TF05	-	1.7	25	40	57	7.8	3.5
	5S3.059.1Y	-	AH	-	-	TF05	-	2.0	41	65	92	12.8	4.0
	5S3.119.1Y	-	AH	AL	-	-	TF07	2.0	60	94	133	18.4	6.0
	5S3.189.1Y	-	-	AL	-	-	TF07	2.0	89	141	199	27.7	7.0
	5S3.239.1Y	-	-	AL	-	-	TF07	2.0	111	175	248	34.3	7.5
	5S3.269.1Y	-	-	AL	AN	-	TF07	2.0	135	213	301	41.8	8.0

E = Narrowest free cross-section · *NPT on request

The maximum tank diameter shown above applies for the recommended operating pressure and is indicative only. The cleaning result is also affected by the type of soiling.

Information on operation

- Operation with compressed air only for short-term usage. Operation above the recommended operating pressure means higher wear and smaller droplets. This might have adverse effects on the cleaning result.

Slip-on information

- R-clip made of stainless steel AISI 316L is included (Ordering no.: 095.022.1Y.50.60.E (5S3), 095.013.1E.05.59.0 (5S2)).
- Depending on diameter of the adapter the flow rate can increase due to leakage between connecting pipe and rotating cleaning nozzle.

Example	Type	+	Connection	=	Ordering no.
of ordering:	5S2.955.1Y.	+	AF	=	5S2.955.1Y.AF



Rotating cleaning nozzle »ACCUClean« Series 515

Series 515

Its exactly controlled rotation makes the ACCUClean extremely efficient. It cleans with powerful flat jets and can be combined with the Lechler rotation monitoring sensor. It is also available in versions with different spray angles.



Function video

Scan the QR-code
or go to:
[www.lechler.de/
AccuCleanGB](http://www.lechler.de/AccuCleanGB)



Max. tank diameter [m]

0 | 1 | 2 | 3 | 4 | 5 | 6 | 7 | 8



Materials

Stainless steel
AISI 316L, PTFE,
PEEK



Max. temperature

140 °C



Recommended operating pressure

3 bar



Installation

Vertically facing
downward



Filtration

Line strainer with
a mesh size of
0.3 mm/50 Mesh



Bearing

Ball bearing made
of stainless steel







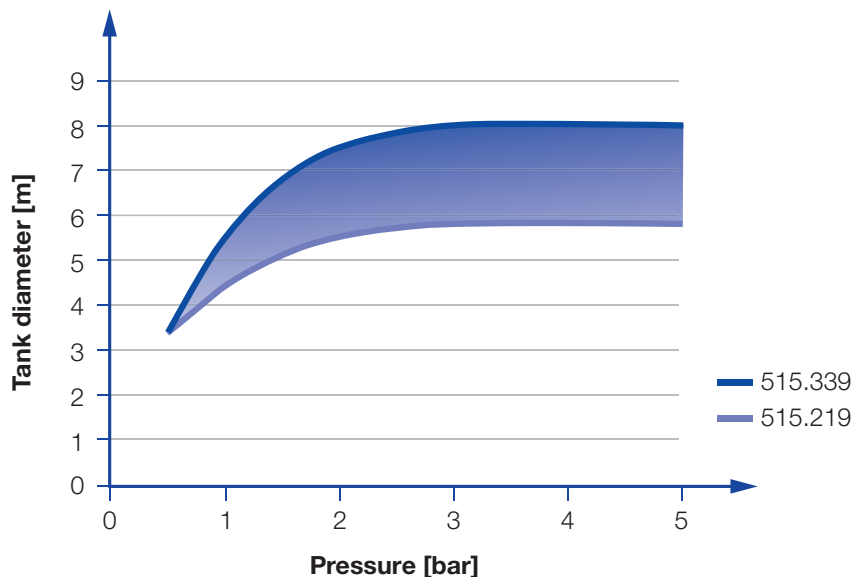

Rotation monitoring sensor

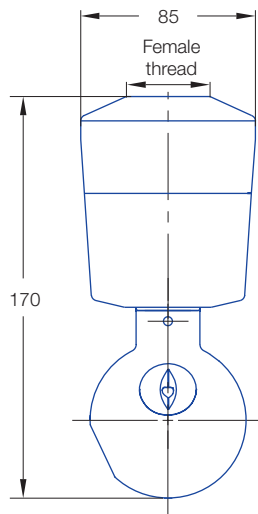
Sensor compatible
Info: see page 60



Overview of the tank diameter, depending upon the pressure of series 515



Spray angle 	Ordering no.			E ∅ [mm]	V̇ [l/min]				Max. tank diameter [m]
	Type	Connection			p [bar] (p _{max} = 10 bar)				
		3/4 BSPP	1 BSPP		2	3	5	at 40 psi [US gal./ min]	
180° 	515.213.7T	AL	-	1.0	97	118	153	30	5.8
180° 	515.214.7T	AL	-	1.0	97	118	153	30	5.8
270° 	515.215.7T	AL	-	1.0	97	118	153	30	5.8
	515.285.7T	AL	-	1.0	145	178	229	45	6.8
270° 	515.216.7T	AL	-	1.0	97	118	153	30	5.8
	515.286.7T	AL	-	1.0	145	178	229	45	6.8
360° 	515.219.7T	AL	-	1.0	97	118	153	30	5.8
	515.289.7T	AL	-	1.0	145	178	229	45	6.8
	515.339.7T	-	AN	1.0	193	237	306	60	8

E = Narrowest free cross-section · *NPT on request

The maximum tank diameter shown above applies for the recommended operating pressure and is indicative only. The cleaning result is also affected by the type of soiling.

Information on operation

- Operation with compressed air only for short-term usage. Operation above the recommended operating pressure means higher wear and smaller droplets. This might have adverse effects on the cleaning result.

Example of ordering: Type **515.213.7T.** + Connection **AL** = Ordering no. **515.213.7T.AL**



Rotation Monitoring Sensor

Cleaning processes can be easily and reliably monitored with the Lechler rotation monitoring sensor. The sensor records the quantity of liquid flowing over the sensor tip. With the aid of the supplied software, the sensor function can be specifically adjusted to the tank size, pressure and nozzle.



Electrical data

- Supply voltage:
Ub = 24 V +/-20%
(18 to 32 VDC)
- Power requirements:
< 20 mA
- Output signal:
PNP, 50 mA short circuit protected, active

Operating conditions

- Ambient temperature:
-10° up to +60°C
- Process temperature:
0° up to +100°C

Materials

- Socket (G 1/2"): AISI 316L
- Probe tip: PEEK
- Body: AISI 303

Advantages

- Reliable recognition of any faults during the cleaning cycle
- The process connection of the sensor is in compliance with the hygiene guidelines of the EHEDG
- Simple operation
- Can be connected to PLC
- Only needs to be set up once using the software provided
- Can be specifically adapted to each cleaning task

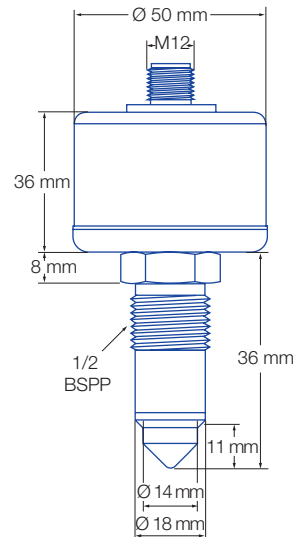

Ordering data

Rotation monitoring sensor with weld-in sleeve
Cable set for first-time operation

Ordering no.

050.040.00.00.00.0
050.040.00.00.01.0

THE EFFECTIVE MEDIUM AGAINST THE MOST PERSISTENT SOILING

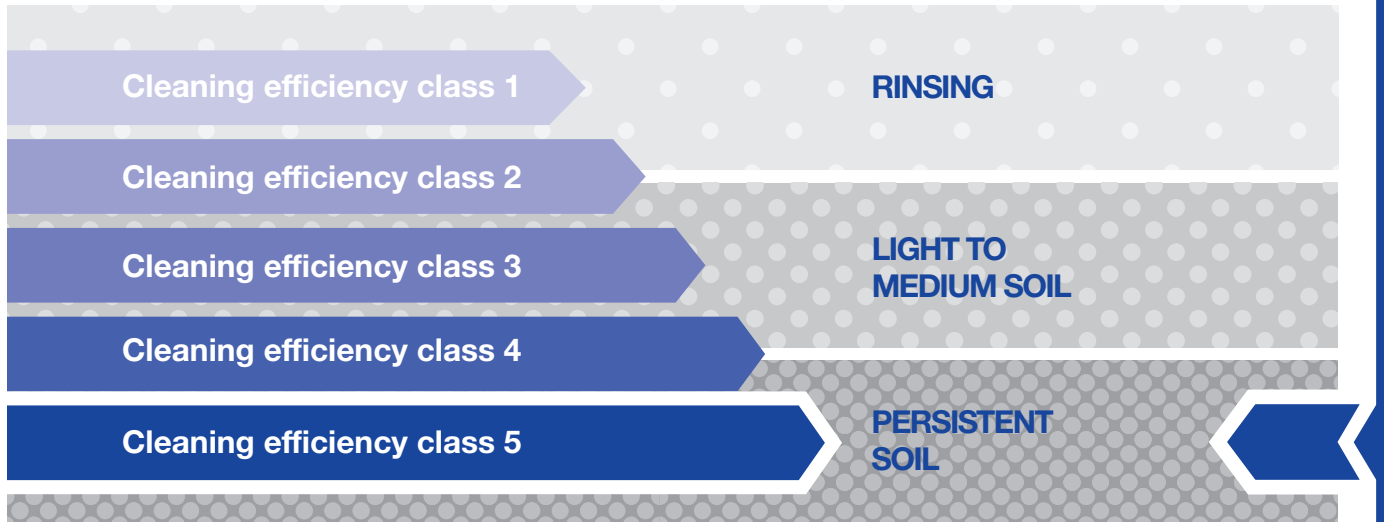

Cleaning efficiency class 5

Persistent soiling requires special measures. That's why the Lechler high impact tank cleaning nozzles in efficiency class 5 are equipped with high-grade gear units and work with deliberately controlled rotation. They prove their capabilities in tasks in the food and beverage industry, the chemical and petrochemical industry and the paper industry.

Solid jet nozzles ensure maximum efficiency and maximum impact. Cleaning efficiency class 5 includes rotating cleaners that are suitable for medium to very large tanks. Process reliability is increased through combination with the Lechler rotation monitoring sensor.



 Max. tank diameter [m]	0	3	6	9	12	15	18	21	24	27
---	---	---	---	---	----	----	----	----	----	----

 **Operating principles**
Gear-controlled

 **Flow rates at 2 bar**
25 to 260 l/min

 **Recommended operating pressures**
5 bar

 **Max. temperatures**
60 to 95 °C



High impact tank cleaning machine

»IntenseClean Hygienic«

Series 5TA

Series 5TA

The IntenseClean Hygienic 5TA is a permanent feature, especially in the pharmaceutical, food and beverage industries. It is extremely effective thanks to the particularly powerful solid jet nozzles and is also suitable for small tanks with persistent soiling. The series can resist pressures of up to 15 bar and high temperatures without any problem. All parts used exhibit a particularly high surface quality.



Function video

Scan the QR-code or go to:
www.lechler.de/IntenseCleanHygienic5TAGB

	Max. Tank diameter [m]	0	3	6	9	12	15	18	21	24	27
--	-------------------------------	---	---	---	---	----	----	----	----	----	----

Materials
 Stainless steel AISI 316L, PTFE, PEEK, Zirconium oxide, EPDM

Max. temperature
 95 °C

Recommended operating pressure
 5 bar

Installation
 Operation in every direction is possible

Filtration
 Line strainer with a mesh size of 0.2 mm/80 Mesh

Bearing
 Ball bearing

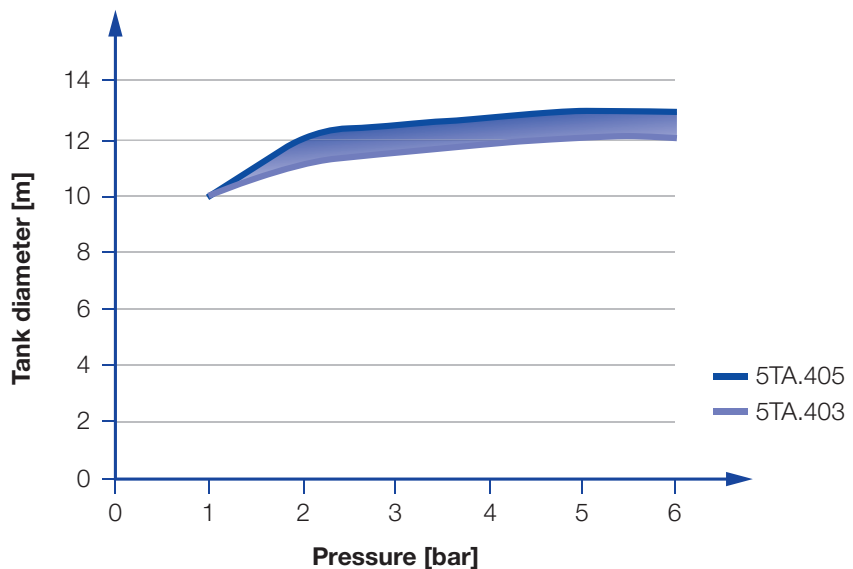

Weight
 0.9 kg

Rotation monitoring sensor
 Sensor compatible, Info: see page 68

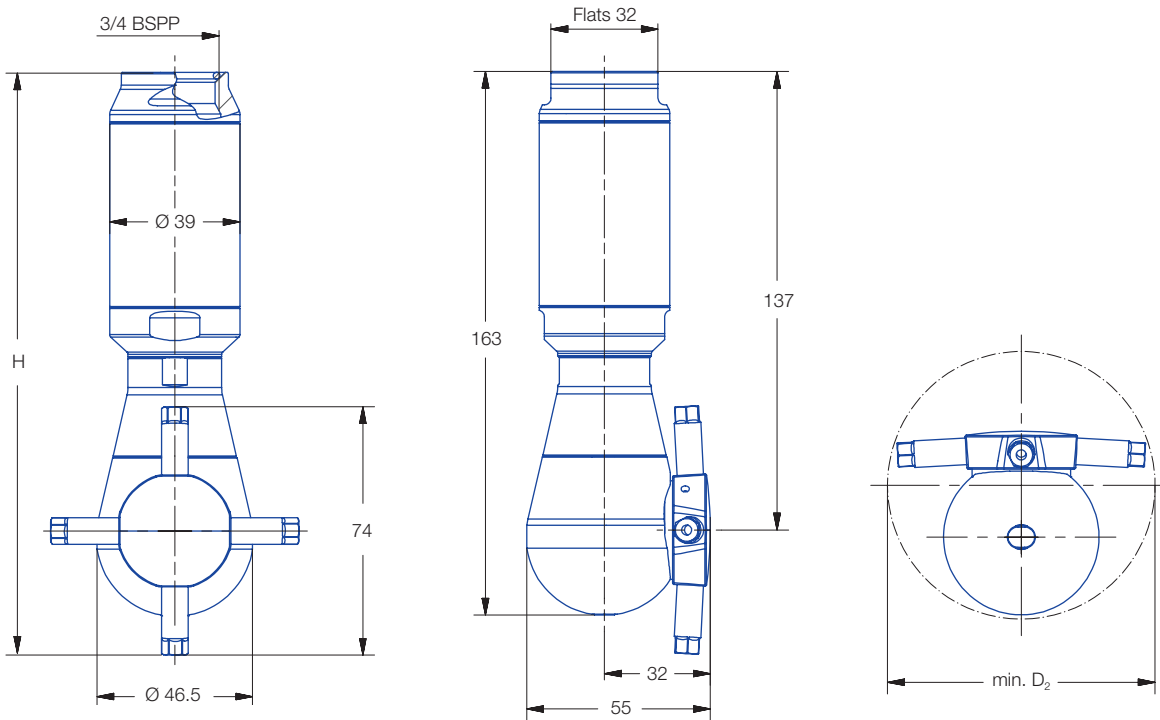

Overview of the tank diameter, depending upon the pressure of series 5TA



Spray angle 	Ordering no. Type	E Ø [mm]	Number. Ø Nozzles [mm]	V̇ [l/min]				Dimensions			Max. tank diameter [m]
				p [bar] (p _{max} = 15 bar)				Height H [mm]	Diameter D ₁ [mm]	Diameter D ₂ [mm]	
				2	5	10	at 40 psi [US gal./ min]				
360° 	5TA.403.1Y.AL	1.5	4 x 3.0	25	40	56	7.8	164	54	68	12.0
	5TA.404.1Y.AL	1.5	4 x 4.0	42	66	93	12.9	164	54	68	12.5
	5TA.405.1Y.AL	1.5	4 x 5.0	50	79	112	15.5	174	74	80	13.0

E = Narrowest free cross-section

The maximum tank diameter shown above applies for the recommended operating pressure and is indicative only. The cleaning result is also affected by the type of soiling.

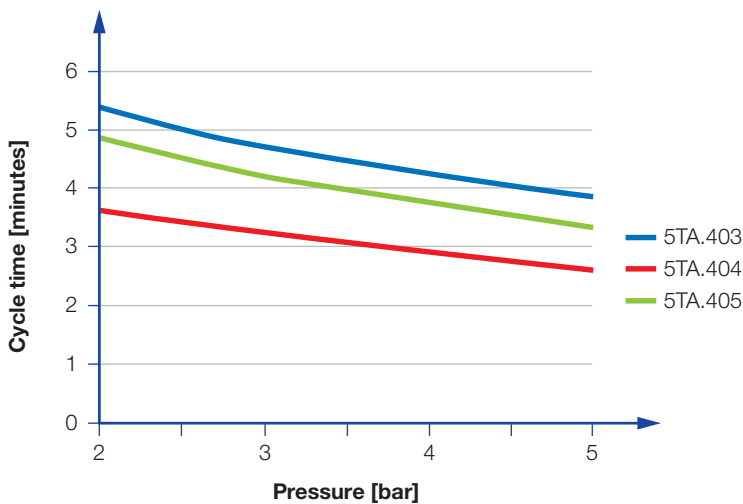

Cycle time depending on pressure of series 5TA



High impact tank cleaning machine

»IntenseClean Hygienic«

Series 5TB

Series 5TB

The IntenseClean Hygienic 5TB has firmly established itself, above all in the pharmaceutical, food and beverage industries – and with good reason: The especially strong solid jets produce an extremely high degree of effectiveness, while the gear-controlled rotation ensures high levels of efficiency. All parts used are noted for their particularly high surface quality. This series is suitable for high pressures and temperatures.



Function video

Scan the QR-code
or go to:
www.lechler.de/IntenseCleanHygienic5TBGB



Max. Tank diameter [m]

0 | 3 | 6 | 9 | 12 | 15 | 18 | 21 | 24 | 27



Materials
Stainless steel AISI 316L, PTFE, PEEK, Zirconium oxide, EPDM



Max. temperature
95 °C



Recommended operating pressure
5 bar



Installation
Operation in every direction is possible



Filtration
Line strainer with a mesh size of 0.2 mm/80 Mesh



Bearing
Ball bearing



Weight
4.0 kg



Rotation monitoring sensor
Sensor compatible,
Info: see page 68



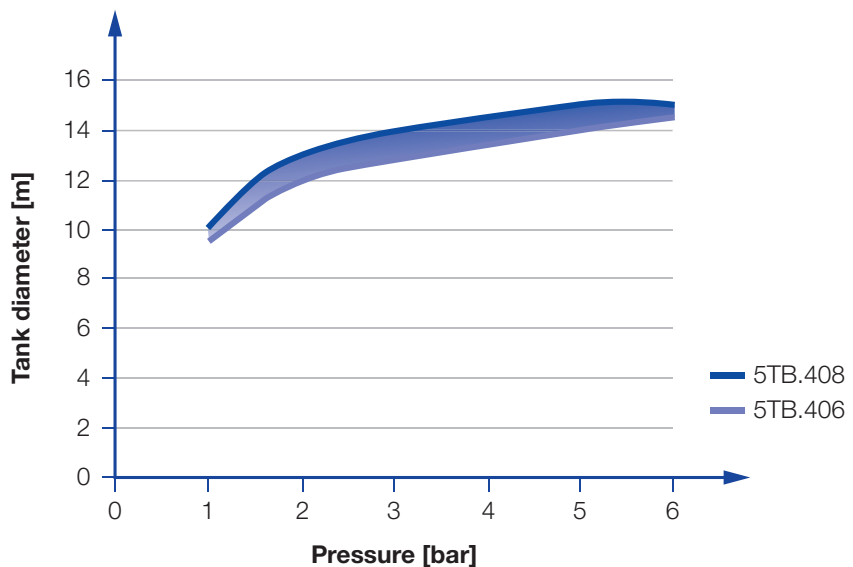

64

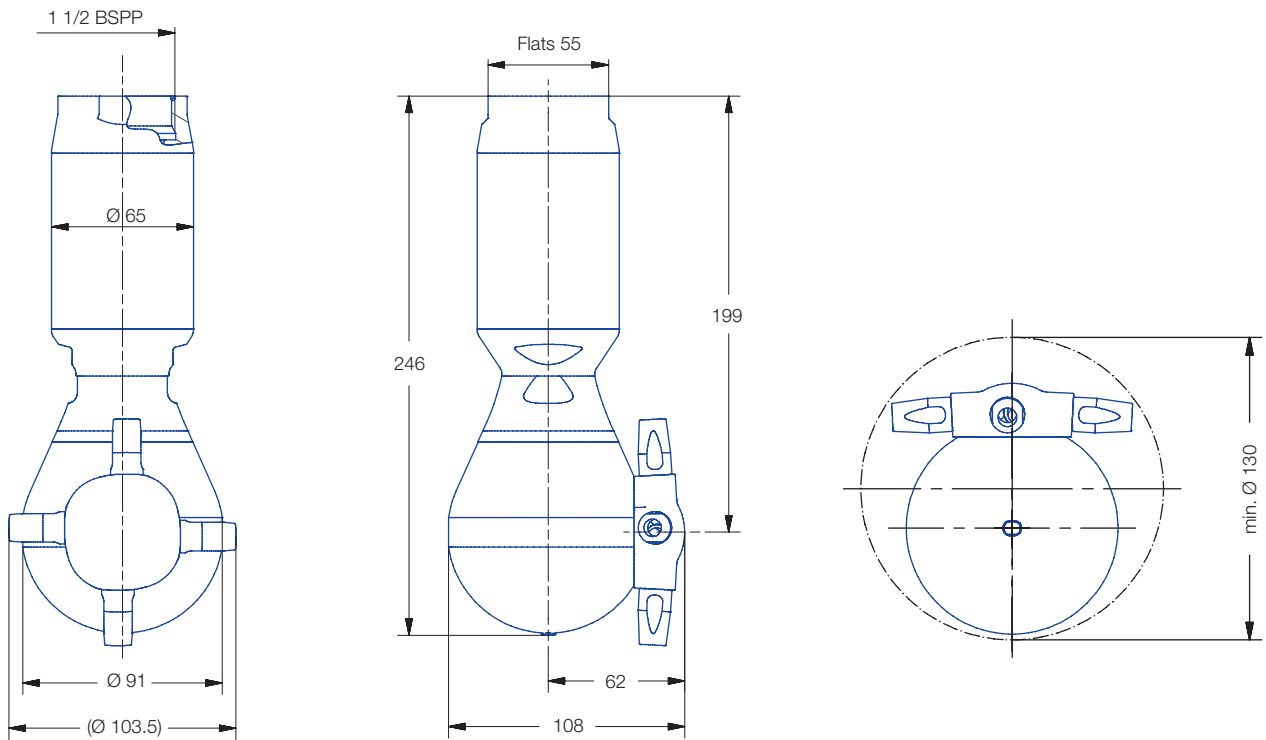

Overview of the tank diameter, depending upon the pressure of series 5TB



Spray angle 	Ordering no. Type	E Ø [mm]	Number, Ø Nozzles [mm]	V̇ [l/min]				Max. tank diameter [m]
				p [bar] (p _{max} = 25 bar)				
				2	5	10	at 40 psi [US gal./ min]	
360° 	5TB.406.1Y.AS	6.0	4 x 6.0	107	169	239	33.1	14.0
	5TB.407.1Y.AS	6.0	4 x 7.0	135	213	302	41.9	14.0
	5TB.408.1Y.AS	6.0	4 x 8.0	165	261	369	51.2	15.0

E = Narrowest free cross-section

The maximum tank diameter shown above applies for the recommended operating pressure and is indicative only. The cleaning result is also affected by the type of soiling.

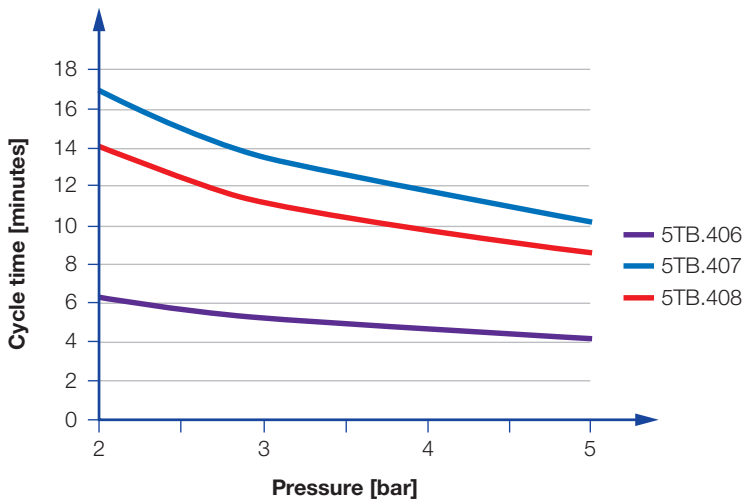

Cycle time depending on pressure of series 5TB



High impact tank cleaning machine

»IntenseClean«

Series 5TM

Series 5TM

The IntenseClean is used in many applications, amongst others in the petrochemical industry. It is noted for its robust and proven construction, effective solid jets and gear-controlled rotation. A version for higher temperatures is also available on request.



Function video

Scan the QR-code or go to:
www.lechler.de/IntenseCleanGB



Max. tank diameter [m]

0 | 3 | 6 | 9 | 12 | 15 | 18 | 21 | 24 | 27



Materials*
 Stainless steel AISI 316L, PTFE, carbon fibre



Max. temperature
 60 °C (Version for higher temperatures on request)



Recommended operating pressure
 5 bar



Installation
 Operation in every direction is possible



Filtration
 Line strainer with a mesh size of 0.2 mm/80 Mesh



Bearing
 Ball bearing



Weight
 7.5 kg



Rotation monitoring sensor
 Sensor compatible, Info: see page 68

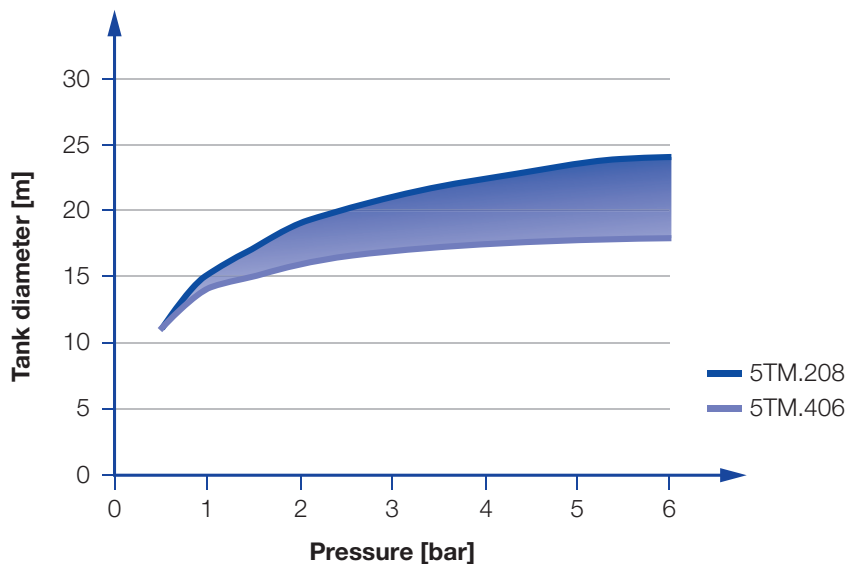

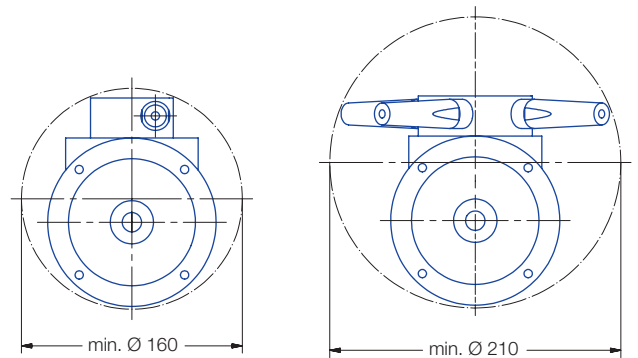
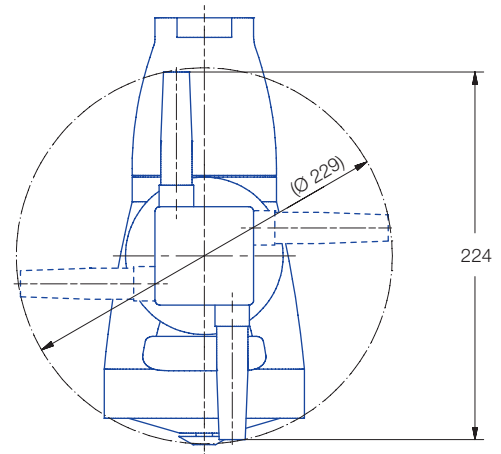
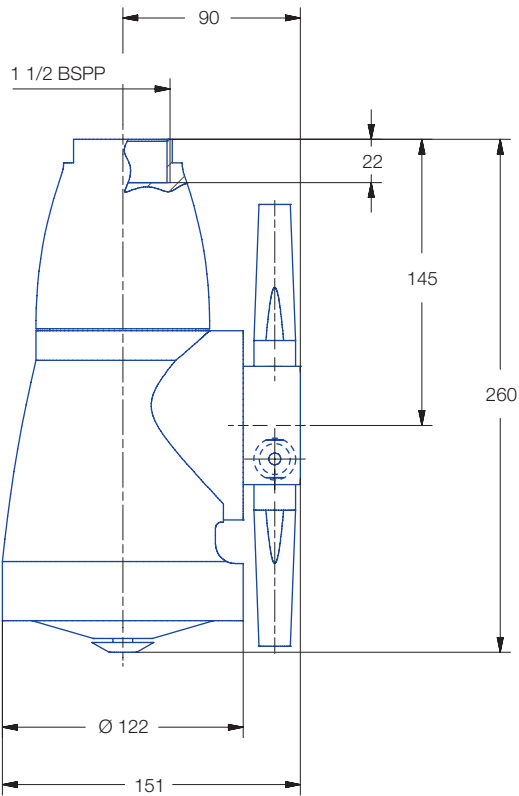

Overview of the tank diameter, depending upon the pressure of series 5TM

*The mentioned materials refer to the main components of the tank cleaning machine. A detailed list of all contained materials is available on request.



5TM.2XX.1Y.AS (2 nozzles)

5TM.4XX.1Y.AS (4 nozzles)

Spray angle 	Ordering no.	E Ø [mm]	Number, Ø Nozzles [mm]	\dot{V} [l/min]				Max. tank diameter [m]
				p [bar] ($p_{max} = 7$ bar)				
				2	3	5	at 40 psi [US gal./ min]	
	5TM.208.1Y.AS	8	2 x 8.0	125	153	198	39	24.0
	5TM.210.1Y.AS	10	2 x 10.0	160	196	253	50	24.0
	5TM.406.1Y.AS	6	4 x 6.0	140	171	221	43	18.0
	5TM.407.1Y.AS	7	4 x 7.0	170	208	269	53	20.0
	5TM.408.1Y.AS	8	4 x 8.0	200	245	316	62	22.0
	5TM.410.1Y.AS	10	4 x 10.0	260	318	411	81	23.0

E = Narrowest free cross-section

The maximum tank diameter shown above applies for the recommended operating pressure and is indicative only. The cleaning result is also affected by the type of soiling.

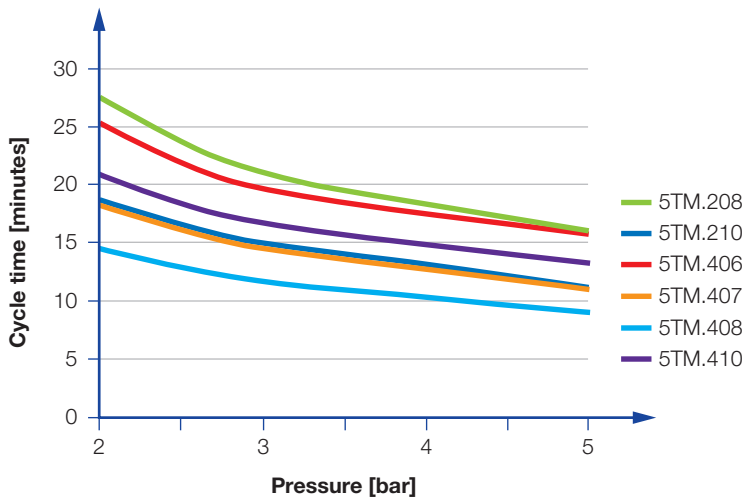

Cycle time depending on pressure of series 5TM



Rotation Monitoring Sensor

Cleaning processes can be easily and reliably monitored with the Lechler rotation monitoring sensor. The sensor records the quantity of liquid flowing over the sensor tip. With the aid of the supplied software, the sensor function can be specifically adjusted to the tank size, pressure and nozzle.



Electrical data

- Supply voltage:
 $U_b = 24\text{ V} \pm 20\%$
(18 to 32 VDC)
- Power requirements:
< 20 mA
- Output signal:
PNP, 50 mA short circuit protected, active

Operating conditions

- Ambient temperature:
-10° up to +60°C
- Process temperature:
0° up to +100°C

Materials

- Socket (G 1/2"): AISI 316L
- Probe tip: PEEK
- Body: AISI 303

Advantages

- Reliable recognition of any faults during the cleaning cycle
- The process connection of the sensor is in compliance with the hygiene guidelines of the EHEDG
- Simple operation
- Can be connected to PLC
- Only needs to be set up once using the software provided
- Can be specifically adapted to each cleaning task

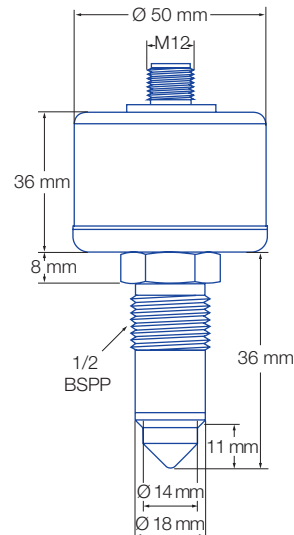

Ordering data

Rotation monitoring sensor with weld-in sleeve
Cable set for first-time operation

Ordering no.

050.040.00.00.00
050.040.00.00.01.0

FOR SPECIAL REQUIREMENTS: OUR STATIC CLEANING NOZZLES

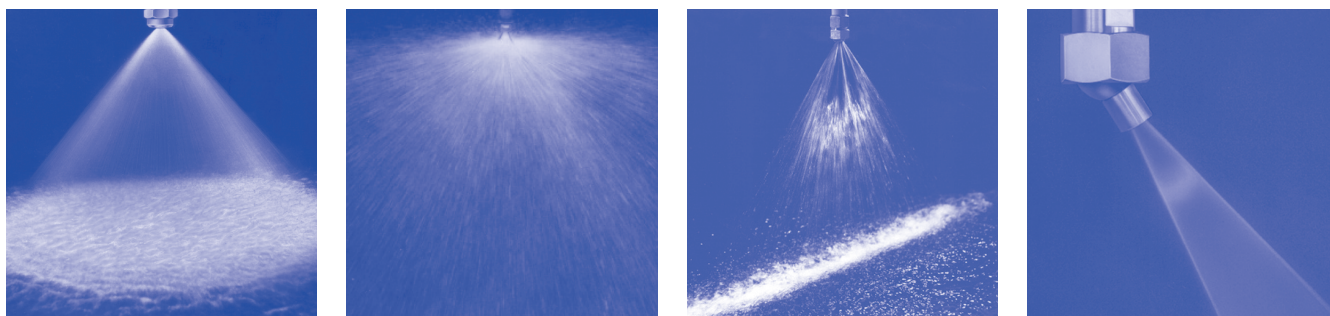

Static cleaning nozzles

The range of applications of the static cleaning nozzles in the support of rotating cleaners focuses on particularly difficult tasks, such as equipment cleaning and the avoidance of spray shadows.

They deliberately support the cleaning efficiency of the process and are used in addition to rotating cleaners or spray balls to reach hard to access places and for removing persistent soiling.



Axial-flow full cone nozzles Series 490 / 491

Non-clogging nozzle design. Stable spray angle. Particularly even liquid distribution.

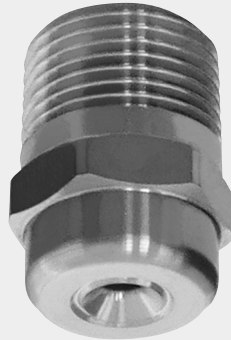

Series 490



Series 491

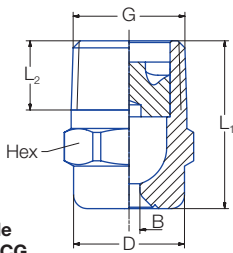

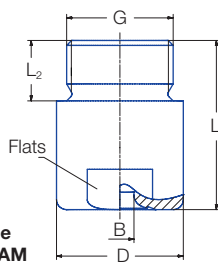

Code
CC-CG



Code
AK-AM

Code	Dimensions [mm]				
	G	L ₁	L ₂	D	Hex/Flats
CC	1/4 BSPT	22.0	10.0	13.0	14
CE	3/8 BSPT	24.5	10.0	16.0	17
CG	1/2 BSPT	32.5	13.0	21.0	22
AK	3/4 BSPP	42.0	15.0	32.0	27
AM	1 BSPP	56.0	17.0	40.0	36

Subject to technical modification.
In a critical installation situation, please ask for the exact dimensions.

Spray angle 	Ordering no.						B ∅ [mm]	E ∅ [mm]	V [l/min]							Spray diameter D 			
	Type	Mat. no. 1Y	Code						p [bar]							at p=2 bar			
			AISI 316L	1/4 BSPT	3/8 BSPT	1/2 BSPT			3/4 BSPP	1 BSPP	0.5	1.0	2.0	3.0	5.0	7.0	10.0	H = 200 mm	H = 500 mm
60°	490.644	○	CC	CE	-	-	-	2.30	2.30	2.30	3.03	4.00	4.70	5.77	6.60	7.61	220	560	
	490.684	○	CC	CE	-	-	-	2.60	2.60	2.87	3.79	5.00	5.88	7.21	8.25	9.52	220	560	
	490.724	○	CC	CE	-	-	-	2.95	2.80	3.62	4.77	6.30	7.41	9.09	10.40	11.99	220	560	
	490.764	○	-	CE	-	-	-	3.25	3.25	4.59	6.06	8.00	9.41	11.54	13.20	15.22	220	560	
	490.804	○	-	CE	-	-	-	3.70	3.70	5.74	7.58	10.00	11.76	14.43	16.51	19.04	220	560	
	490.844	○	-	-	CG	-	-	4.05	4.05	7.18	9.47	12.50	14.70	18.03	20.63	23.80	220	560	
	490.884	○	-	-	CG	-	-	4.65	4.65	9.19	12.13	16.00	18.82	23.08	26.41	30.46	220	560	
	490.924	○	-	-	-	AK	-	5.20	5.20	11.49	15.16	20.00	23.52	28.85	33.01	38.07	220	560	
	490.964	○	-	-	-	AK	-	5.80	5.80	14.36	18.95	25.00	29.40	36.07	41.26	47.59	220	560	
	491.044	○	-	-	-	-	AM	7.25	7.25	22.97	30.31	40.00	47.04	57.71	66.02	76.15	220	560	
	491.084	○	-	-	-	-	AM	8.15	8.15	28.72	37.89	50.00	58.80	72.14	82.53	95.18	220	560	

E = Narrowest free cross-section · B = Bore diameter



Deflector-plate nozzle Series 524 / 525

Full cone spray. Non clogging nozzle without swirl insert.

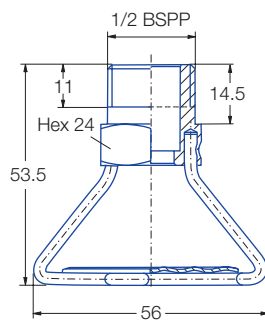

Type 524. 809 – 525. 269

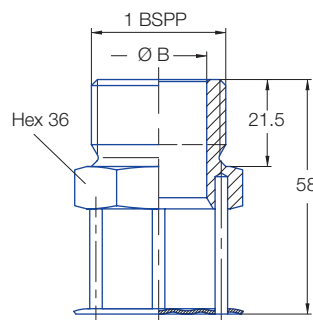

Type 525. 349 – 525. 489

Spray angle 	Ordering no.		B Ø [mm]	\dot{V} [l/min]						Spray diameter D [m]	
	Type	Mat. no. 17 ¹ AISI 316Ti/AISI 316L		p [bar]						at p=3 bar ca.	
				0.5	1.0	2.0	3.0	5.0	10.0	H = 1 m	H = 3 m
180°	524.809	○	4.00	5.00	7.10	10.00	12.20	15.80	22.40	5.60	6.40
	524.969	○	6.20	12.50	17.70	25.00	30.60	39.50	55.90	8.00	9.00
	525.049	○	8.00	20.00	28.30	40.00	49.00	63.20	89.40	10.00	13.20
	525.269	○	12.30	70.00	99.00	140.00	171.00	221.00	313.00	5.20	10.20
	525.349	○	16.20	112.00	158.40	224.00	274.30	354.20	500.80	4.80	9.70
	525.469	○	23.80	222.70	315.00	445.50	545.60	704.40	996.20	4.50	9.50
	525.489	○	25.30	250.00	353.60	500.00	612.40	790.60	1118.00	4.00	9.00

B = Bore diameter

¹We reserve the right to deliver AISI 316Ti or AISI 316L under the material no. 17.



Flat fan nozzles Series 632 / 633

Standard design with conical, self-sealing thread connection. Stable spray angle. Uniform, parabolic distribution of liquid.

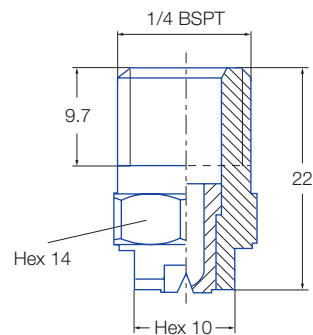

1/4" version

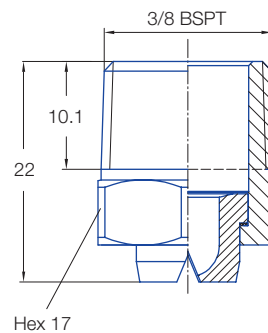

3/8" version

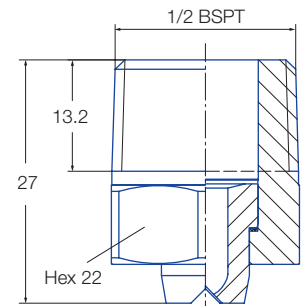

1/2" version



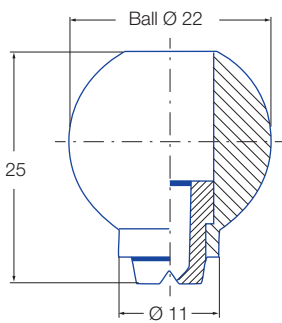

Flat fan nozzles with ball joint Series 676

Swivelling nozzle for precise adjusting of jet direction. No gaskets necessary. Long, unproblematic service life.

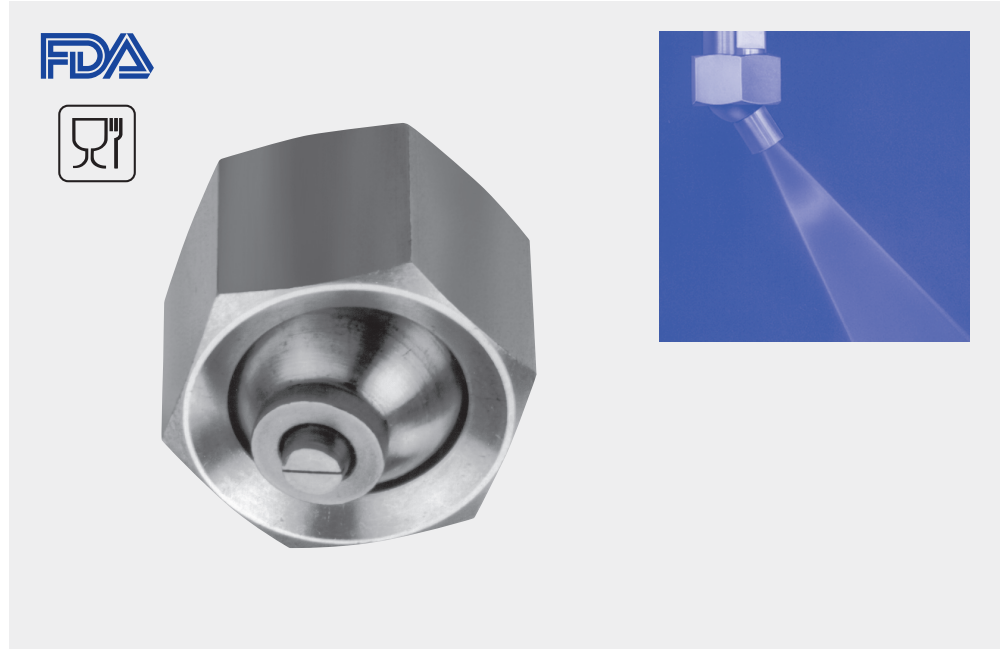

Allround swivelling by 30°



Spray angle 	Ordering no.		A Ø [mm]	E Ø [mm]	V̇ [l/min]						Spray width B  at p=2 bar	
	Type	Mat. no.			p [bar] (p _{max} = 30 bar)						H = 250 mm	H = 500 mm
		16 AISI 303			0.5	1.0	2.0	3.0	5.0	10.0		
30°	676.642	○	2.50	1.80	2.00	2.83	4.00	4.90	6.33	8.94	120	240
	676.722	○	3.00	2.40	3.15	4.46	6.30	7.72	9.96	14.09	125	240
	676.762	○	3.50	2.70	4.00	5.66	8.00	9.80	12.65	17.89	125	245
	676.802	○	4.00	3.10	5.00	7.07	10.00	12.25	15.81	22.36	130	250
45°	676.643	○	2.50	1.80	2.00	2.83	4.00	4.90	6.33	8.94	195	370
	676.723	○	3.00	2.40	3.15	4.46	6.30	7.72	9.96	14.09	200	375
	676.763	○	3.50	2.60	4.00	5.66	8.00	9.80	12.65	17.89	200	380
	676.803	○	4.00	3.00	5.00	7.07	10.00	12.25	15.81	22.36	205	385
60°	676.644	○	2.50	1.60	2.00	2.83	4.00	4.90	6.33	8.94	295	565
	676.674	○	2.70	1.80	2.38	3.36	4.75	5.82	7.51	10.62	300	575
	676.724	○	3.00	2.10	3.15	4.46	6.30	7.72	9.96	14.09	305	590
	676.764	○	3.50	2.30	4.00	5.66	8.00	9.80	12.65	17.89	310	595

E = Narrowest free cross-section · A = Equivalent bore diameter



Flat fan nozzles with ball joint Series 676 – Accessories

Retaining nut
092. 020. 16. 00. 02
Material: AISI 303

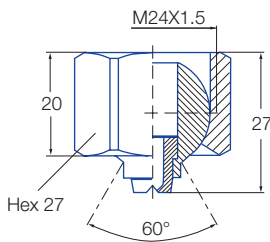
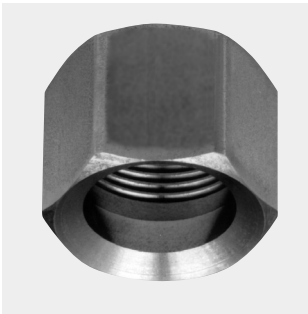

Socket
092. 020. 16. AF. 03
Material: AISI 303

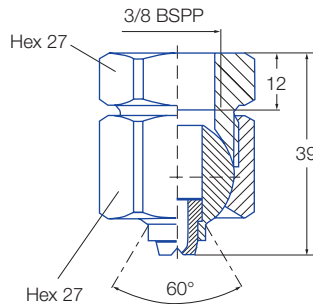

Retaining nipple
092. 024. 16. AC. 03
Material: AISI 303

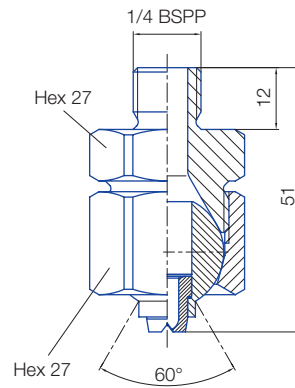

Welding nipple
092. 020. 17. 00. 04
Material: AISI 316Ti

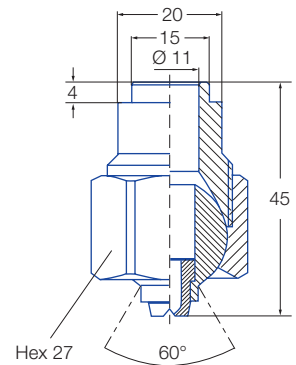

Compact ball joints for narrow installation conditions

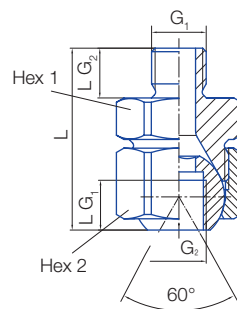

For series	Ordering no.			Dimensions						
	Type	Mat. no.	Code	G ₁ BSPP	G ₂ BSPP	L _{G1} [mm]	L _{G2} [mm]	L [mm]	Hex ₁	Hex ₂
		16 AISI 303								
For all nozzles with 1/8" male thread	092.010	○	AA	1/8A	1/8	8.0	8.0	29.3	22	24
For all nozzles with 1/4" male thread	092.024	○	AC	1/4A	1/4	12.0	12.0	44	27	27
For all nozzles with 3/8" male thread	092.030	○	AE	3/8A	3/8	12.0	12.0	44	27	30

YOU CAN FIND MORE NOZZLES IN OUR STANDARD CATALOGUE ...

The catalogue „Precision Spray Nozzles and Accessories“ is a sought-after manual of nozzle technology.

It contains valuable working aids and extensive technical information on Lechler products and ordering instructions.

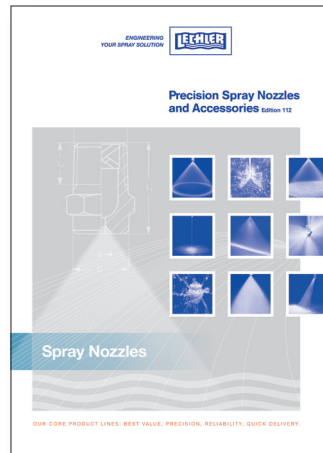

... AND IN OUR INDUSTRY BROCHURES

Information is available for various industries in special industry brochures.

All documents can be downloaded from our website at www.lechler.com. We would also be happy to send you the brochures.



Brochure „Precision Spray Nozzles for the Food and Beverage Industry“

Brochure „Precision Spray Nozzles for the Chemical Industry“

Brochure „Precision Spray Nozzles for Surface Technology“

THE IDEAL SOLUTION TO THE PERFECT NOZZLE

NOZZLE SELECTION QUESTIONNAIRE



Nobody knows your process and requirements better than you. Your knowledge is critical to us in order to find the optimal nozzle for your application.

Simply fax us the completed questionnaire or enter your information online.

www.lechler.com/tankcleaning/questionnaire_tankcleaning

FULL INFORMATION IS JUST A CLICK AWAY: THE LECHLER WEBSITE



Our website contains further information on our products as well as useful resources. In addition to technical data, there is also a product finder to help you in your search for the right nozzle.

www.lechler.com

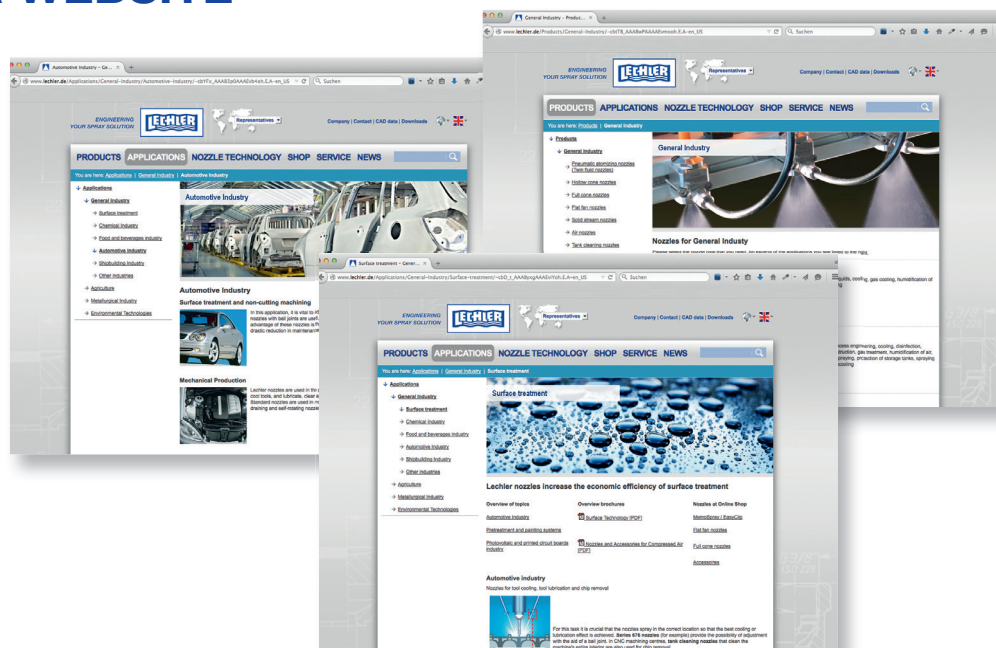

3D DESIGN DATA FOR YOUR WORK



So you can work on your designs with reliable data from the outset, free 3D data on Lechler nozzles and accessories are available to you online.

- Your advantages:
- Time-saving, immediate download of design drawings and technical data
 - Simple, fast product selection
 - Preview function with product photo and 3D graphics
 - All popular 3D formats available
 - Free use following one-time registration

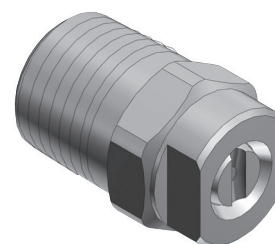

<http://lechler.partcommunity.com>

FOR YOUR NOTES





**ENGINEERING
YOUR SPRAY SOLUTION**



LECHLER WORLD-WIDE

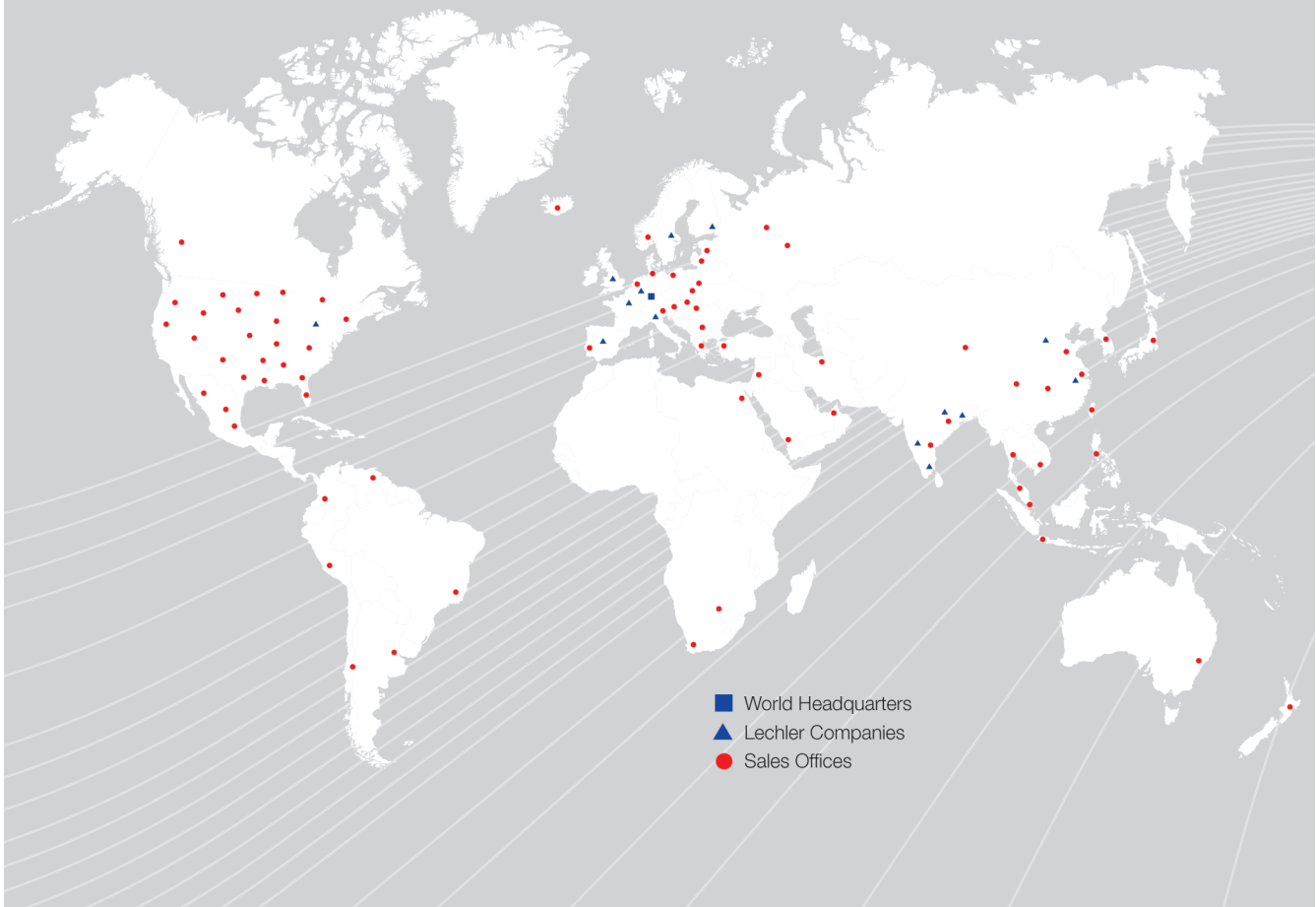

Lechler GmbH · Precision Nozzles · Nozzle Systems

P.O. Box 13 23 · 72544 Metzingen, Germany · Phone: +49 7123 962-0 · Fax: +49 7123 962-333 · info@lechler.de · www.lechler.com

Belgium: Lechler S.A./N.V. · Avenue Mercatorlaan, 6 · 1300 Wavre · Phone: +32 10 225022 · Fax: +32 10 243901 · info@lechler.be

China: Lechler Intl. Trad. Co. Ltd. · Beijing · Rm. 418 Landmark Tower · No. 8 Dong San Huan Bei Lu · Phone: +86 10 84537968, Fax: +86 10 84537458 · info@lechler.com.cn

Finland: Lechler Oy · Jäspilänkatu 18 · 04360 Kerava · Phone: +358 207 856880 · Fax: +358 207 856881 · info@lechler.fi

France: Lechler France, S.A. · Bât. CAP2 · 66-72, Rue Marceau · 93558 Montreuil cedex · Phone: +33 1 49882600 · Fax: +33 1 49882609 · info@lechler.fr

Great Britain: Lechler Ltd. · 1 Fell Street, Newhall · Sheffield, S9 2TP · Phone: +44 114 2492020 · Fax: +44 114 2493600 · info@lechler.com

India: Lechler (India) Pvt. Ltd. · Plot B-2 · Main Road · Wagle Industrial Estate · Thane (W) - 400604 · Phone: +91 22 40634444 · Fax: +91 22 40634497 · lechler@lechlerindia.com

Italy: Lechler Spray Technology S.r.l. · Via Don Dossetti, 2 · 20080 Carpiano (Mi) · Phone: +39 02 98859027 · Fax: +39 02 9815647 · info@lechleritalia.com

Sweden: Lechler AB · Kungsängsvägen 31 B · 753 23 Uppsala · Phone: +46 54 137030 · Fax: +46 54 137031 · info@lechler.se

Spain: Lechler S.A. · Avda. Pirineos 7 · Oficina B7, Edificio Inbisa I · 28700 San Sebastián de los Reyes, Madrid · Phone: +34 91 6586346 · Fax: +34 91 6586347 · info@lechler.es

USA: Lechler Inc. · 445 Kautz Road · St. Charles, IL, 60174 · Phone: +1 630 3776611 · Fax: +1 630 3776657 · info@lechlerUSA.com